

**WIN** MEKAMON V2  
WORTH **£250**



**W/** COULD WE BUILD...  
**WESTWORLD?**

# HOW IT WORKS

FEATURING  
LIVESCIENCE



**REAL-LIFE RAPTORS**  
Discover the deadly weapons of today's dinosaurs

THE MAGAZINE THAT FEEDS MINDS™

14,200-TON  
DIGGER



SKYLAUNCH  
SUPERPLANE



WORLD'S BIGGEST  
CRUISE LINER

# MEGA MACHINES

HOW WE BUILD  
AND OPERATE  
THESE TITANIC  
VEHICLES



NASA'S ROCKET  
TRANSPORTER



HOUSE-SIZED  
DUMPTRUCK

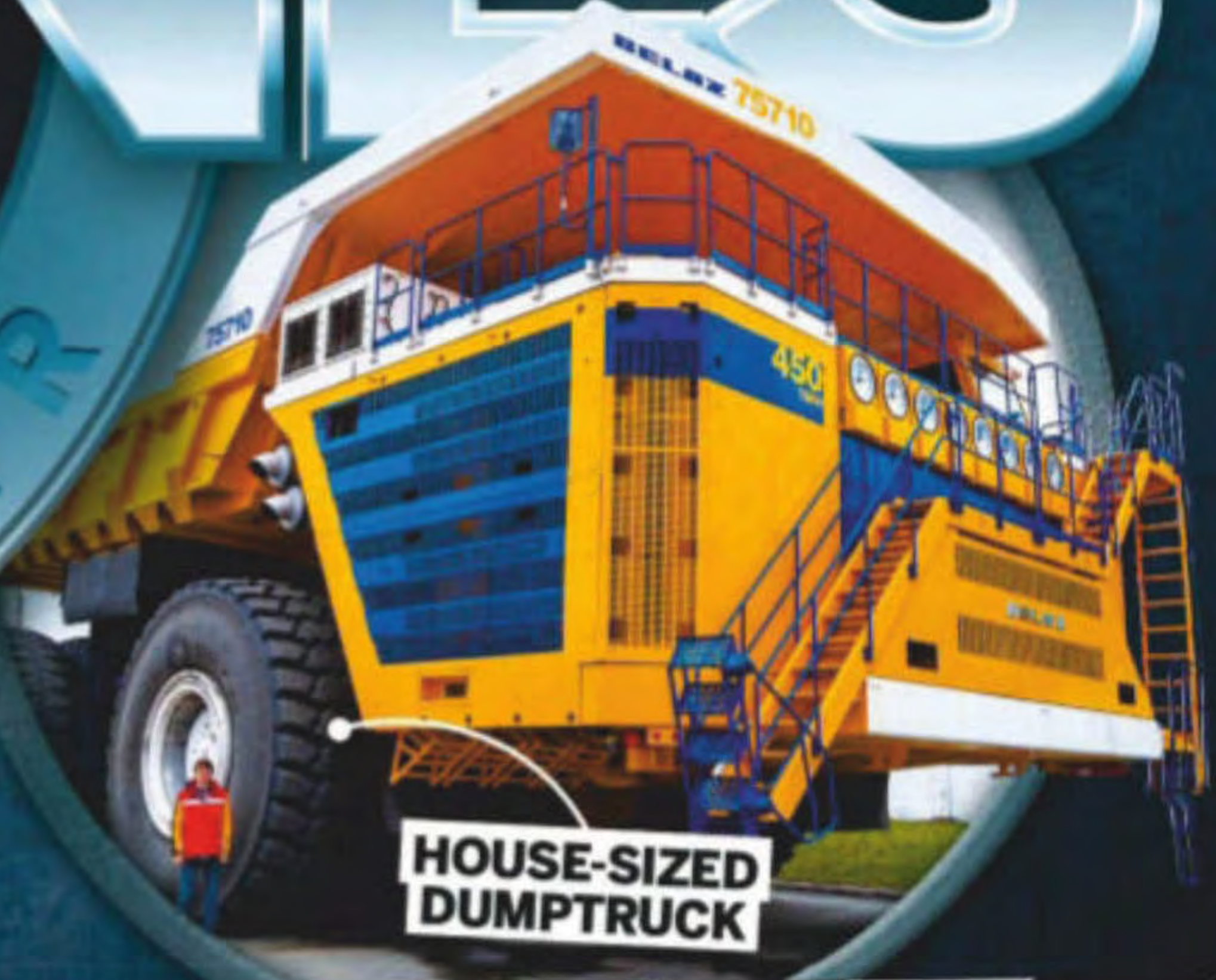

## SPACE LASERS

From guiding satellites to communicating with aliens



WHAT MAKES  
PEOPLE TICKLISH



EXPLORING  
JUPITER'S ASTEROIDS



CAR CRASH  
SAFETY TESTING

**+** INSIDE THE CITY OF CAVES **AREA 51: THE TRUTH** HOW WATERLOO WAS WON

# WELCOME

The magazine that feeds minds!

# DISCOVER

## LANDS UNKNOWN

### Embark on a Unique Journey

Explore the endless wilderness with *Discover: Lands Unknown*, a new Unique Game from Fantasy Flight Games! When you find yourself stranded in an unfamiliar environment, you and your friends must explore to survive! Every copy of *Discover: Lands Unknown* is completely unique, distinct from every other copy in the world! Do you have what it takes to survive?

DSC01 £57.99

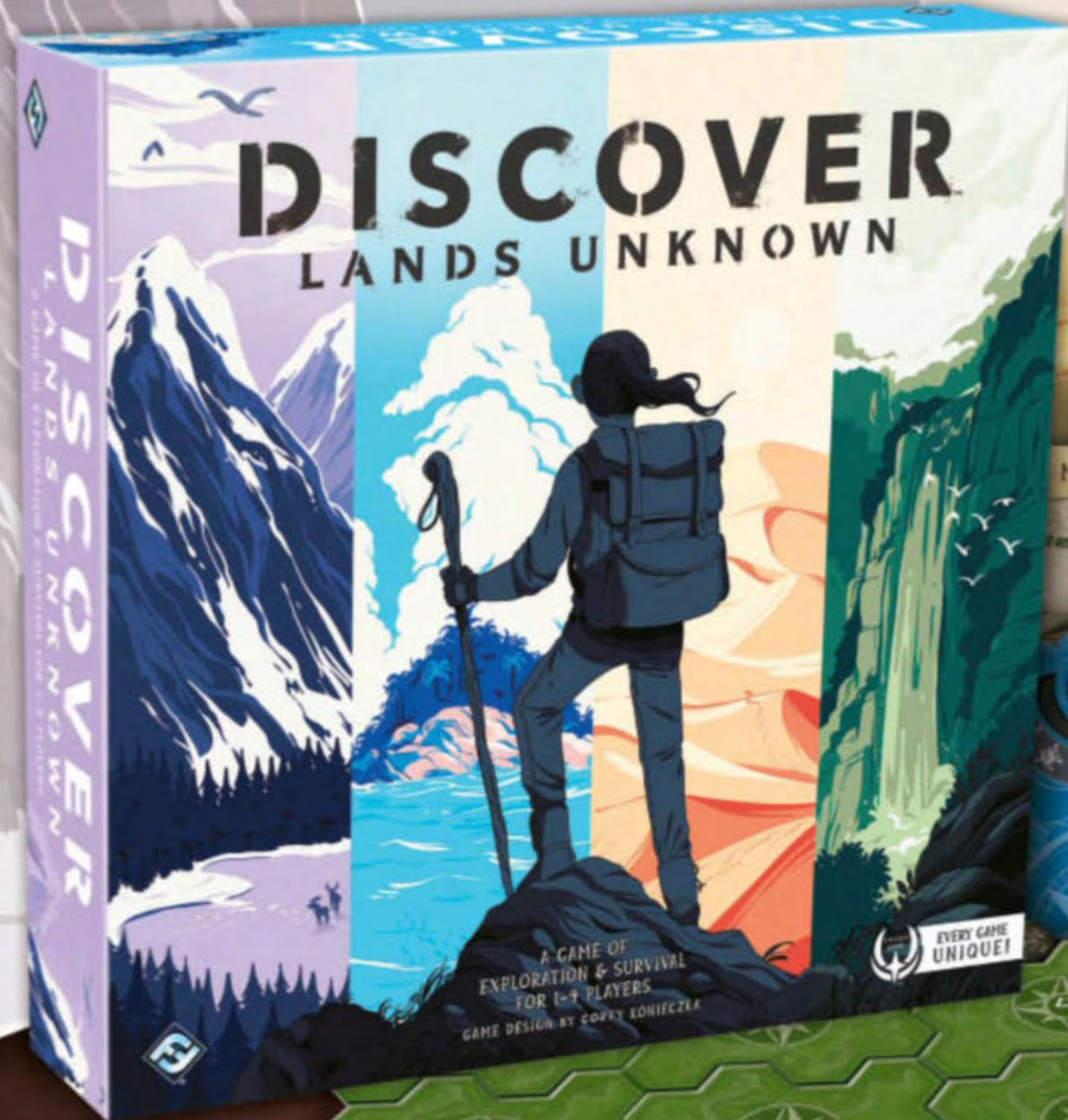

For exclusive HIW news and offers, sign up to our mailing list [howitworksdaily.com/newsletter](http://howitworksdaily.com/newsletter)



The sheer scale of the machines that humans have been able to build since the late-20th century is astonishing. The Bagger 293, which spearheads a by no means exhaustive list of vehicles in our cover feature seems impossibly massive – so big it makes me question not just how they built it, but why. I like to think that part of the reason that all 14,200 tons of this giant bucket-wheel excavator was

assembled was because its manufacturer simply loved big machines! Also this issue, we delve into the world of airborne predators and what makes raptors the perfect hunters, find out how close we are to realising the technology of the android theme park in HBO's *Westworld*, learn how Napoleon lost the Battle of Waterloo and explore the science of the electromagnetic spectrum. Enjoy!  
**Ben Biggs**  
Editor

*"It extracts enough coal to power several million homes"*  
Mega Machines, page 22

### Meet the team...



**Charlie G**  
Production Editor  
Napoleon's defeat at Waterloo was a critical moment in history. Turn to page 74 to find out how close he came to victory.



**Baljeet**  
Research Editor  
From destroying space junk to monitoring Earth, space lasers have many functions. Learn more over on page 66.



**Charlie E**  
Staff Writer  
Are you getting ready to start spring cleaning the house? Find out about the science behind the products you will be using on page 40.



**Scott**  
Staff Writer  
Birds of prey are prolific predators. Discover how these feathered hunters are perfectly adapted to take down their prey on page 44.



**Duncan**  
Senior Art Editor  
As a *Westworld* fan I was fascinated to read about the technology that could make it possible to build a real-life *Westworld* park one day.

FOLLOW US... [f](https://www.facebook.com/HowItWorksMagazine) How It Works magazine [@HowItWorksmag](https://twitter.com/HowItWorksmag)



# CONTENTS

## TRANSPORT

- 22 **Mega machines**  
We examine the technology that drives some of the world's most colossal vehicles
- 30 **Crash testing cars**

## SCIENCE

- 34 **Electromagnetism explained**  
How meddling with the EM spectrum has changed the scientific world forever
- 40 **The chemistry of cleaning**
- 42 **Why tickling makes us laugh**

## ENVIRONMENT

- 44 **How birds of prey hunt**  
The incredible tools raptors use to bring down their prey
- 50 **Wildlife of Canada's boreal peatlands**
- 53 **Rapid river waves**
- 54 **Earth in a year**
- 56 **The foam-nest frog**

## TECHNOLOGY

- 58 **Could we build... Westworld?**  
How we'll construct the theme park of tomorrow's world
- 64 **Inside the city of caves**
- 65 **Meet the prototypes**

## SPACE

- 66 **Space lasers**  
From guiding spacecraft to destroying apocalyptic asteroids, we explore the many applications of this exciting technology
- 70 **What is string theory?**
- 73 **Exploring the Trojan asteroids**

## HISTORY

- 74 **How the Battle of Waterloo was won**  
When Napoleon Bonaparte returned from exile he was confronted with two armies blocking his road to power. If the Little Corporal was to regain his empire he would have to crush both of them
- 80 **The Lincoln Memorial**
- 82 **The truth about Area 51**



22 **Mega machines**



66 **Space lasers**



44 **How birds of prey hunt**



82 **The truth about Area 51**

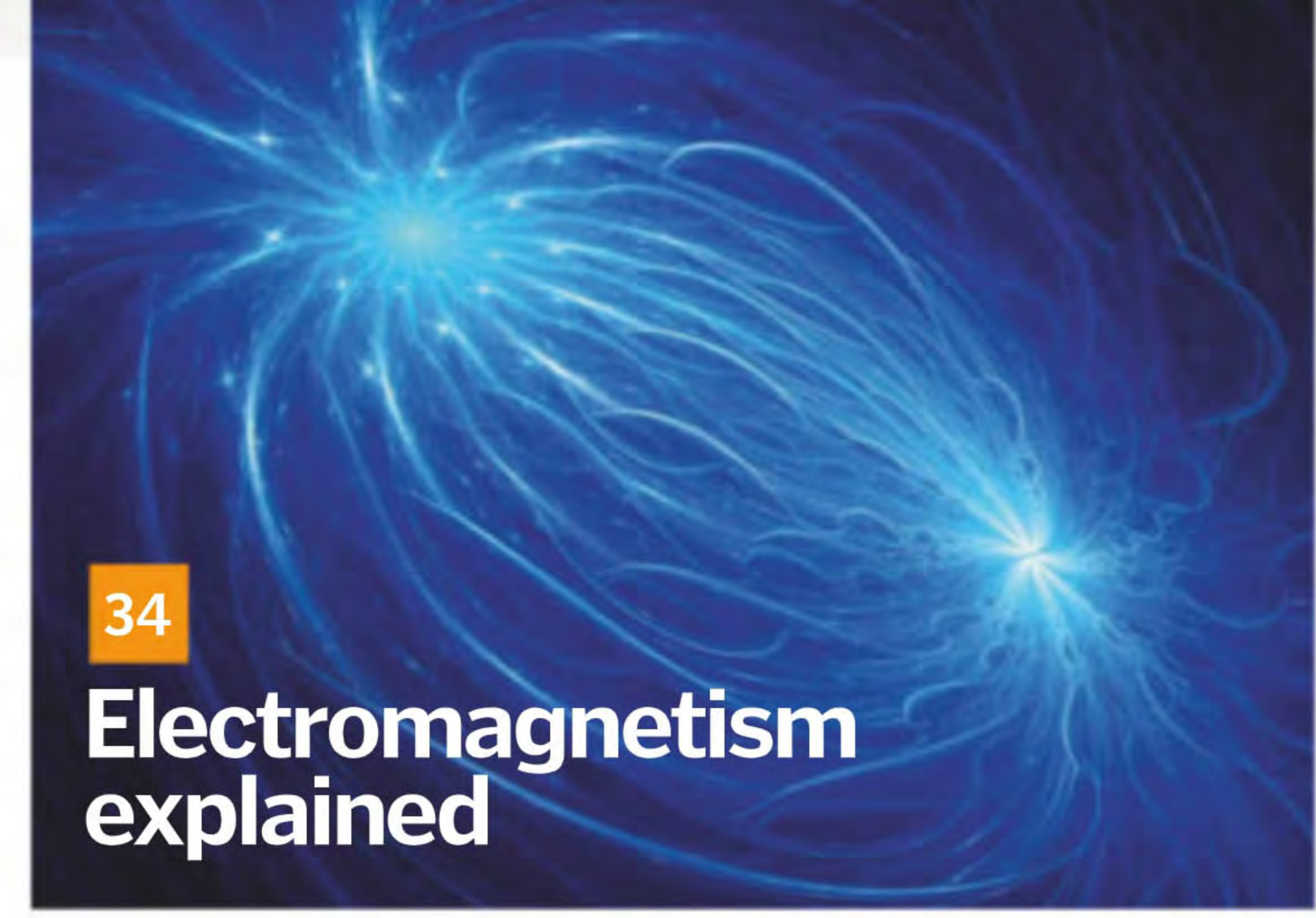

34 **Electromagnetism explained**



42 **Why tickling makes us laugh**

**WIN**  
A MECHAMON V2 WORTH £249.99!  
Page 95



58 **Could we build... Westworld?**

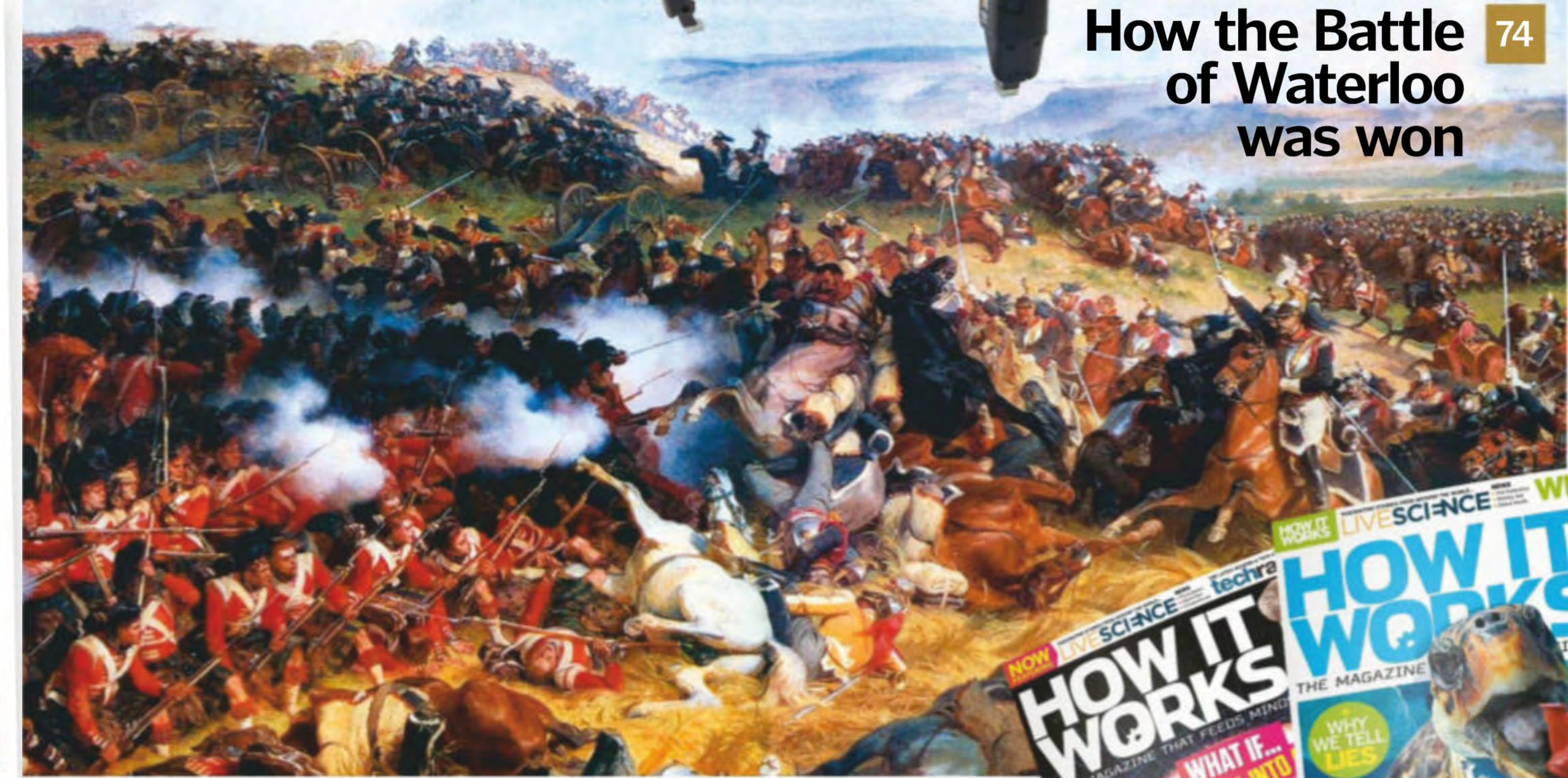

74 **How the Battle of Waterloo was won**

# REGULARS



- 06 **Global eye**  
Science and tech news from around the world
- 16 **Wish list**  
The gadgets, games and apps we've got our eye on
- 18 **Interview**  
We talk to physicist Jim Al-Khalili about the future of AI
- 84 **Brain dump**  
Your questions answered
- 90 **Book reviews**
- 92 **Brain gym**  
Give your brain a workout with our puzzle pages
- 94 **How to...**  
Put a candle out with CO2
- 96 **Letters**  
Our readers have their say
- 98 **Fast facts**

## MEET THIS ISSUE'S EXPERTS...



- James Horton**  
Former HIW member James is a biochemist and biotechnologist. He is currently doing a PhD in machine learning and evolutionary theory.
- Jo Stass**  
Jo has been a writer and editor for over six years. She is particularly interested in the natural world and technological innovations.
- Jodie Tyley**  
The former Editor of HIW and All About History has tackled many topics in her career, from science fiction to science fact and Henry VIII to honey badgers.
- Jonathan O'Callaghan**  
With a background in astrophysics, former HIW and All About Space journalist Jonathan enjoys delving into the wonders of space.
- Laura Mears**  
Biomedical scientist Laura escaped the lab to write about science and is now working towards her PhD in computational evolution.
- Stephen Ashby**  
Stephen has been a writer and editor for over seven years. He is endlessly intrigued by technology and Earth science.
- Steve Wright**  
Steve has worked as an editor on many publications. He enjoys looking to the past, having also written for All About History and History Of War.
- Tim Williamson**  
History Of War Editor Tim has a passion for all things military but studies and writes about a range of historical eras.
- Tom Lean**  
Tom is a historian of science at the British Library working on oral history projects. His first book, *Electronic Dreams*, was published in 2016.
- Victoria Williams**  
Evolutionary biologist and former World of Animals writer Vicky is fascinated by nature and happiest when outdoors.



**SUBSCRIBE NOW!**  
GO TO PAGE 32 FOR GREAT DEALS

## Into the Blue Hole

Found 70 kilometres off the coast of Belize, the bottom of the Great Blue Hole, the world's second deepest underwater sinkhole, was long unexplored. In December 2018, billionaire entrepreneur Sir Richard Branson and a crew took a mini-sub down into its 124-metre depths and discovered evidence that the hole hadn't always been underwater.



## Life deep underground

These unidentified microscopic worms, imaged by extreme life researcher Gaetan Borgonie, were found over a mile beneath the surface in a South African gold mine. The sample they were found in had been sealed away in the crust for up to 12,300 years, and these organisms were thriving despite the extreme pressure, temperature and low oxygen of their environment.

With over 14 million global monthly users, **Live Science** makes every day a little more interesting by illuminating the fascinating world around us. For the science geek in everyone, **Live Science** breaks down the stories behind the most interesting news and photos on the internet.

TECH

## 'Tunnelbot' could seek out life on Europa

Words by Rafi Letzter

A group of scientists want to send a nuclear-powered 'tunnelbot' to Europa to blaze a path through the Jovian moon's thick shell of ice and search for evidence of life below.

Europa, the fourth largest of Jupiter's 53 named moons, is one of the best candidates in the Solar System for hosting alien life. Researchers believe that its icy crust hides a liquid-water ocean and that vents through that crust might deliver the necessary heat and chemical ingredients for life into that ocean. To peek beneath that thick veil of ice researchers on the NASA Glenn Research COMPASS team think they have come up with the solution: the tunnelbot.

At the 14 December 2018 meeting of the American Geophysical Union, the researchers presented a proposal for a tunnelbot that would use nuclear power to melt a path through Europa's shell, "carrying a payload that can search for [...] evidence for extant/ extinct life."

The tunnelbot, the researchers reported, could use either an advanced nuclear reactor or some of NASA's radioactive 'general-

purpose heat bricks' to generate heat and power, though the radiation would present some design challenges.

Once on the frozen moon – located 628 million kilometres from Earth – the tunnelbot would move through the ice hunting for smaller lakes inside the shell or any evidence that the ice itself might contain life. As it burrowed deeper it would spit out a long fibre-optic cable behind itself leading up to the surface and deploy communications relays at depths of five, ten and 15 kilometres.

Once it reached the liquid ocean, to keep from 'falling through' it would deploy cables or a floatation device to lock itself in place, the researchers wrote.

At this stage this is just a rough theoretical proposal. The researchers haven't actually designed the payload for sampling Europa's water and ice or figured out how to get the tunnelbot onto the moon.

Still, the proposal provides a fascinating window into what a future robotic mission to Europa might look like and how we might eventually begin to explore whether the distant moon harbours life.

An artist's impression of the proposed 'tunnelbot' in action



Europa's thick shell of ice conceals a mysterious ocean, that is potentially home to alien life

ANIMALS

## Giant prehistoric shark was too hot to avoid extinction

Words by Mindy Weisberger

New research suggests the megalodon's body temperature may have played a part in its demise. A giant prehistoric predator that still fuels nightmares and fascinates scientists today, this massive fish could grow to up to 21 metres long, and it took down prey with a terrifying mouthful of teeth measuring up to 18 centimetres.

Fearsome though this giant hunter was, it disappeared from the oceans about 2.6 million years ago. Scientists have now turned to the body temperature of *Otodus megalodon* to offer an explanation as to why it died out.

The megalodon is thought to have been able to thermoregulate (adjust) its body temperature in response to cooler or warmer water, enabling it to hunt in a broad range of habitats. But was megalodon's body temperature similar to that of modern sharks? To find out, scientists used

geochemistry to examine rare carbon and oxygen isotopes in megalodon teeth and in the teeth of modern sharks. These isotopes form different bonds depending on the animal's temperature when teeth form, researcher Michael Griffiths, an associate professor in the Department of Environmental Science at William Paterson University in New Jersey, told Live Science.

With this method, scientists could estimate what the ancient beast's average body

*"It could grow up to 21 metres long and took down prey with 18-centimetre teeth"*

temperature may have been and thereby find clues that might explain how megalodon's biology or habits doomed it to extinction. Preliminary results suggested that megalodon was "quite warm" for a shark, Griffiths said. Ancestors of today's makos and great white sharks that swam alongside megalodons millions of years ago likely had body temperatures of about 20 to 30 degrees Celsius. By comparison, megalodons may have been running a body temperature as high as 35 to 40 degrees Celsius, the body temperature of whales.

This means the megalodon must have had a very active metabolism that required frequent feeding. When the climate warmed the megalodon's prey moved to cooler waters at higher latitudes. Food scarcity and competition from new predators may have combined to drive the megalodon to extinction, Griffiths explained.

Weighing up to 60 tons, the megalodon is the largest predator every to have roamed the Earth



© NASA, Alexander Pawlusk, LERCIP Internship Program NASA Glenn Research Center, Shutterstock

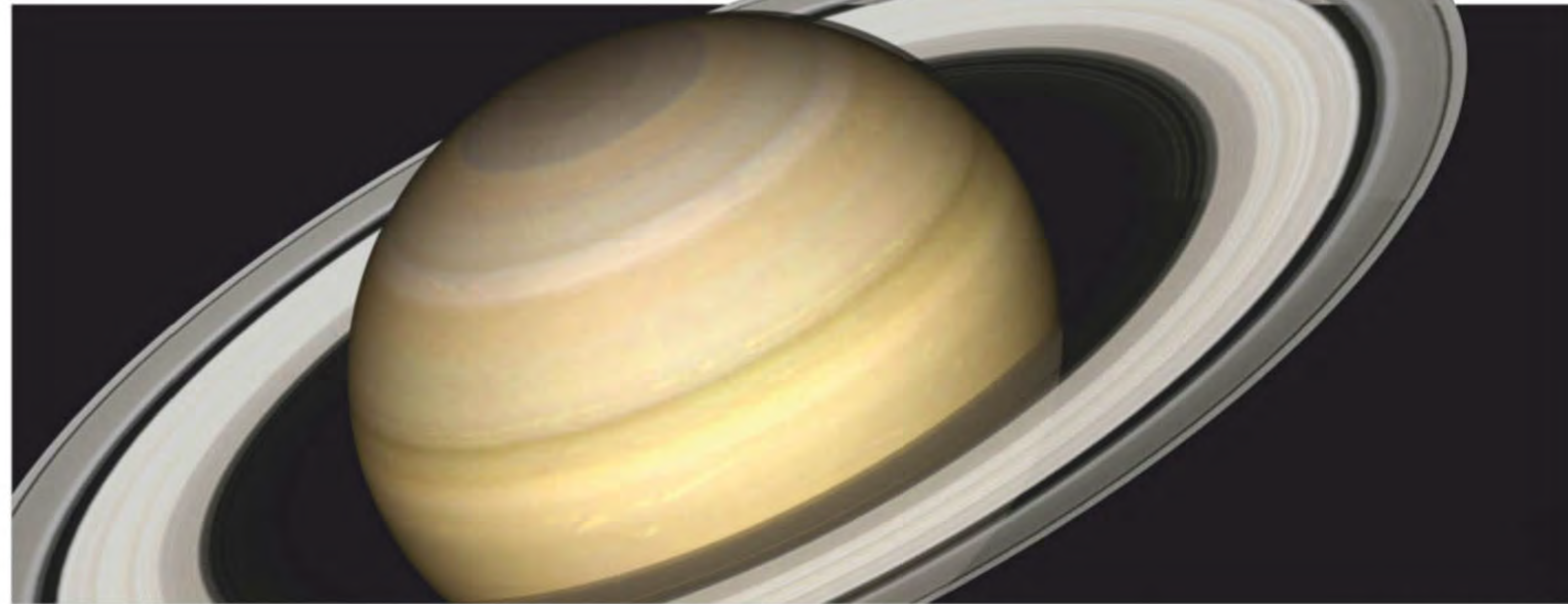

The Cassini spacecraft captured this stunning view of Saturn and its rings on 25 April 2016

**SPACE**

## Saturn is losing its rings

Words by **Meghan Bartels**

Chances are, you wouldn't recognise Saturn without its trademark thick band of rings. But if you could travel 300 million years into the future, you would need to, because by then it's likely those rings would be gone – and they could disappear even faster.

That's the conclusion of a recent investigation into a phenomenon called 'ring rain', which pulls water out of Saturn's rings and into the planet's midlatitude regions. Combined with research from last year using Cassini data to look at a different type of inflow from the rings to the planet, that find means the stunning

structures could be gone in as little as 100 million years, a brief time in universal terms.

The new research relies on ground-based observations gathered over a couple of hours in 2011 from Hawaii of a special form of hydrogen that glows in infrared light. That specific form of hydrogen makes up the ring rain phenomenon.

The results were stark. If the sheer volume of ring rain the scientists spotted during those few hours is typical for Saturn's weather forecast then that rain would eat up a huge amount of the icy rings, between 420 to 2,800 kilograms every second! That incredible rate, combined with the

current mass of Saturn's rings, is what lets scientists calculate that 300-million-year life expectancy, although the large range on the infall calculation means there's quite a bit of uncertainty about the rings' lifetime.

The fate of the rings looks even grimmer considering research published last year using data from Cassini, which looked at a different, more voluminous type of infall from Saturn's rings that is descending onto the planet. Together the two phenomena could gorge through the rings in around the estimated 100 million years.

**HEALTH**

## Bubbles can be a bacteria-spreading menace

Words by **Rachael Rettner**

Innocent-looking bubbles can serve as a launching pad to spread bacteria from water into the air, according to a new study. Published in the journal *Physical Review Letters*, it found that bacteria can manipulate the physics of bubbles in a way that enhances the microbes' spread. For example, bacteria-covered bubbles can last for a much longer time than clean bubbles, even though the bubble's surface thins out over time. Then, once they burst, these thinner bubbles create many more droplets, which are launched into the air at a faster rate compared with clean bubbles. They found that when bubbles were contaminated with *E. coli* they lasted ten-times longer than clean bubbles before bursting. This means the contaminated bubbles lasted for minutes as opposed to seconds. Further investigations revealed that the bubbles lasted longer because the bacteria were secreting substances that acted to reduce the bubble's surface tension, making it more elastic, the researchers said.

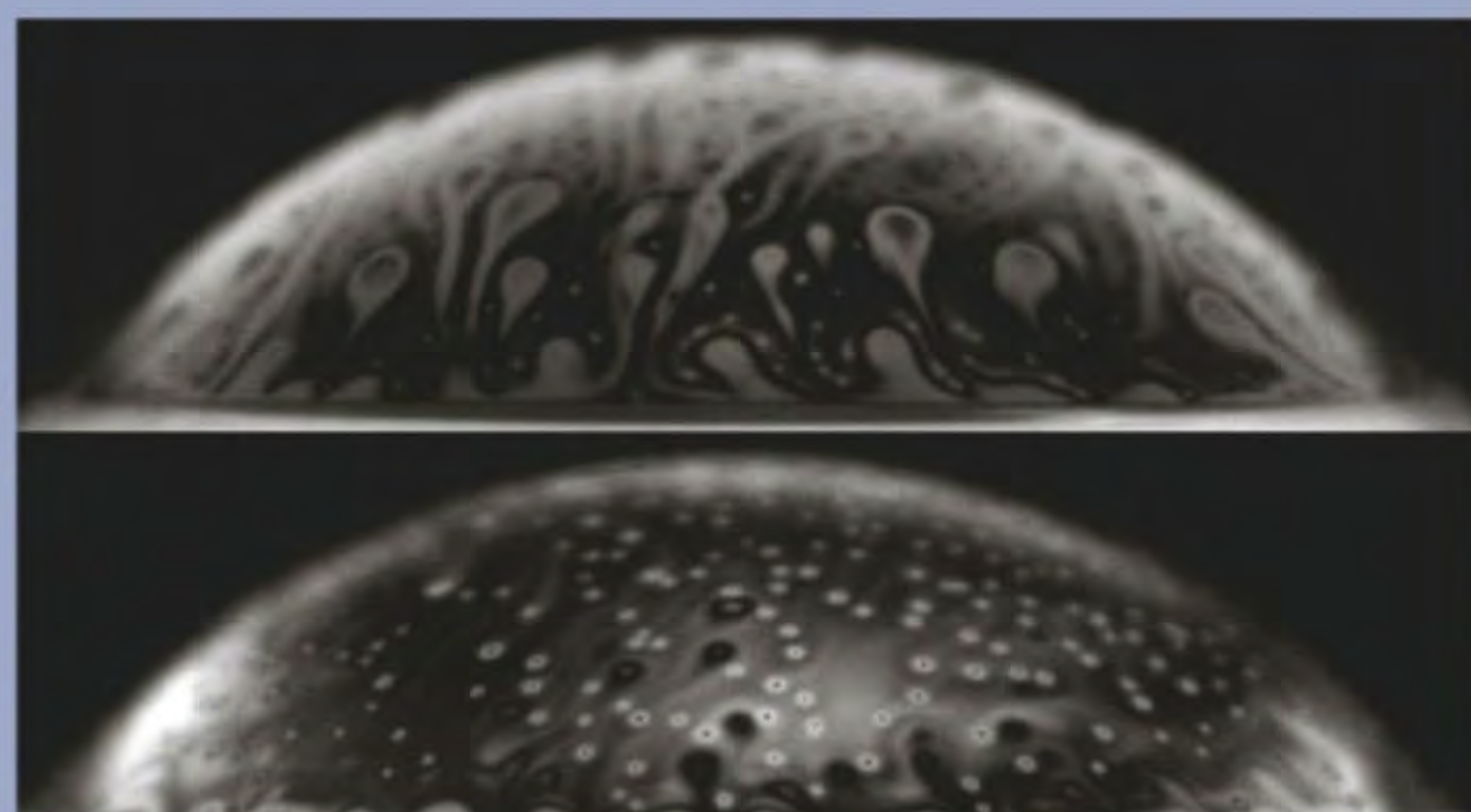

A bubble contaminated with bacteria (shown in the bottom panel) lasts much longer than a clean bubble

**PLANET EARTH**

## World's biggest natural jigsaw puzzle

Words by **Brandon Specktor**

Chilling between the Arctic Ocean and Siberia's frigid northern seas lies the cluster of rocks known as the New Siberian Islands. Viewed on foot, the islands are a near-uninhabited canvas of tundra covered in snow roughly three-quarters of the year. However, satellite images posted by the NASA Earth Observatory have shown the bleak islands looking entirely different.

In a photo snapped by the Landsat 8 satellite in June 2016, the Anzhu Islands (a subset of the New Siberian Islands) meet the sea in a giant jigsaw puzzle of cracking ice. According to NASA, it's not unusual for ice to cling to these frosty islands year-round, though, "The appearance of this ice can change on a daily basis, altered by currents, winds, and seasonal cycles of freezing and melting."

When above-freezing summertime temperatures briefly free the islands from their regular snow cover, gorgeous ice mosaics like this one emerge for anyone quick enough (and airborne enough) to see them.

A few weeks earlier, NASA wrote, and this same landscape would be completely white. A few months later and the snow would return again for another long Arctic winter.

For a small period of time the remote New Siberian Islands turn into a jigsaw puzzle of fractured ice, as seen in this NASA image captured by the Landsat 8 satellite

© NASA/JPL-Caltech/Space Science Institute; Lydia Bourouba and Stephanie Poulain, Massachusetts Institute of Technology; Shutterstock; NASA Earth Observatory; Lauren Dauphin, using Landsat data from the U.S. Geological Survey and MODIS data from NASA EOSDIS/LANCE and GIBS/Worldview

STRANGE NEWS

## How to survive the Game of Thrones, according to science

Words by Stephanie Pappas

If you want to survive in *Game of Thrones*, it pays to be noble, female and flexible about the concept of loyalty.

In a newly published study (yes, really), epidemiologists at Macquarie University in Australia analysed the deaths of the key characters in the HBO series and found that nobles died at a lower rate than commoners, and women died at a lower rate than men. Switching allegiances, like Tyrion Lannister does by throwing in his lot with Daenerys Targaryen, is another winning strategy.

The researchers found that 73.7 per cent of all deaths in the show were caused by injuries, with wounds to the head and neck leading the pack. Another 11.8 per cent of deaths came from burns, and 4.8 per cent were from poisonings. Only two characters, Maester Aemon and Old Nan, have died of natural causes.

"The risk of death is high among characters in *Game of Thrones*," said injury epidemiologist Reidar Lystad of the Australian Institute of Health Innovation. "By the end of the seventh season, more than half the characters had died – 186 out of the 330 characters we included – with violent deaths being the most common."

The median survival time of characters was 28 hours and 48 minutes of show time, with lifespans ranging from a mere 11 seconds to 57 hours and 15 minutes.



16.5 million people watched the finale of season seven of *Game of Thrones*



The bloodthirsty Vlad the Impaler may have been imprisoned in this Transylvanian castle

HISTORY

## What hides beneath Dracula's Transylvanian castle?

Words by Mindy Weisberger

A historic Transylvanian castle that may have once imprisoned Vlad the Impaler – likely the inspiration for Bram Stoker's bestseller *Dracula* – still stands today. But what lies beneath it? New research that uses radar scans of the ground beneath the structure is beginning to reveal what's hidden below the building's imposing facade.

Castelul Corvinilor – also known as Corvin Castle, Hunedoara Castle or Hunyadi Castle – began as a fortress built in central Transylvania (now Romania). In the 15th century the bloodthirsty despot Vlad III, prince of Wallachia (better known as Vlad the Impaler) was purportedly imprisoned in Castle Corvin by Hungarian Governor John Hunyadi (Ioan de Hunedoara). The building is a hodgepodge of construction from

different periods, said lead researcher Isabel Morris, a doctoral candidate with the Department of Civil and Environmental Engineering at Princeton University in New Jersey. It has also been the subject of numerous excavations. However, maps of the site are inconsistent and much of the archaeological record is missing, presenting challenges to scientists exploring the castle today, Morris explained. For this reason, she and her colleagues chose ground-penetrating radar (GPR) to conduct their surveys.

The scans helped the researchers identify an administrative complex built during the 17th century. The radar also revealed places where parts of the castle were held up by bedrock and supported by built-up human-made structures.

Reconstructed rooms in the castle's depths include a torture chamber, but it is unknown if the grim chamber ever housed Vlad the Impaler.

www.howitworksdaily.com

For more of the latest stories head to **livescience.com**

With over 27 million global monthly users, **TechRadar** is packed with breaking news, expert in-depth reviews, fantastic features and easy-to-follow how to guides for anyone unashamedly obsessed with tech.



If Ford's new kennel goes into production, dogs like this one will sleep through the rowdiest party

NEWS

## Ford fights fireworks with noise-cancelling kennel

Words by Cat Ellis

Car manufacturer Ford has created a noise-cancelling kennel to keep man's best friend safe and happy from outside sounds, such as fireworks.

Research by the Royal Society for the Prevention of Cruelty to Animals (RSPCA) has revealed that 43 per cent of dogs in the UK show signs of fear when exposed to the sound of fireworks. Ford's kennel uses the same technology found in vehicles and noise-cancelling headphones to protect pups' sensitive ears and help stop them panicking.

The dog house, which is only a prototype for now, is insulated with high-density cork and a sound system that emits opposing frequencies to cancel loud noises (or at least dramatically reduce them). The idea was inspired by the noise-damping technology used in the Ford Edge SUV, which uses the car's audio system to cancel noise while driving.

Sound-proofing is one way to protect pets from loud noises, but technology is providing other options. Fireworks are a long-standing tradition for marking special occasions such as New Year in spectacular fashion, but drone light shows are gaining popularity as a bang-free alternative.

Intel's Shooting Star Drones are specifically designed for the purpose and can be programmed using regular 3D modelling software to create three-dimensional

www.howitworksdaily.com

animations in the night sky that won't start your four-legged friend.

Such displays are gaining popularity, but for now experts say that pet owners should take care and make sure their pets feel safe and comfortable during celebrations.

"While softer-sounding alternatives could be a step in the right direction, it's important for pet owners to take necessary steps now to keep their pets safe if their community is putting on a traditional firework display," says Dr Pamela Reid, vice president of the anti-cruelty behaviour team at the American Society for the Prevention of Cruelty to Animals (ASPCA). "Pet owners can visit [www.aspc.org](http://www.aspc.org) for tips on how to keep pets safe and calm."



If you're a dog owner you'll know just how stressful New Year's Eve or Bonfire Night can be for a canine

NEWS

## NASA staff hit by hackers

Words by Anthony Spadafora

Nasa has revealed that it suffered a data breach last year. In an internal memo sent out to all of its employees, the American space agency explained that an unknown third party had managed to gain access to one of its servers, which contained the personal data – including the social security numbers – of both current and former NASA employees.

NASA discovered the hack at the end of October but waited two months before notifying its employees. While the agency's reason for waiting so long to disclose the hack is unclear, it is a common practice of US law enforcement to have organisations that fall victim to a hack to wait to reveal the details of a breach during their initial investigation.

NASA has confirmed that it is currently working with federal cybersecurity partners in an effort to "examine the servers to determine the scope of the potential data exfiltration and identify potentially affected individuals".

The agency is still unaware of the full extent of the breach, though in its memo it explained that it is notifying all employees so that they can take the necessary precautions to prevent fraud.

NASA has stressed the fact that uncovering all of the details of the breach will take time, although it did reassure the public that none of its missions were jeopardised by the hack.



In 2000 a 15-year-old hacker shut down the computers used to support the ISS

© NASA, Alexander Pawlusk, LERCIP Internship Program NASA Glenn Research Center, Getty, Alamy

# WISH LIST

The latest must-have technology



## MekaMon V2

Price: £249.99 / \$249.99 [www.mekamon.com](http://www.mekamon.com)

Meet MekaMon, the world's first gaming robot, now available to fight the virtual fight in your living room. The accompanying app will act as your interface into the virtual world, where you can face off with opponents through augmented reality. MekaMon isn't just about bringing robot wars to your home but also a lively and interactive personality. With the use of several smartphone controls, MekaMon can crawl around and explore, but even without direct control this robot will let you know how it's feeling and can even be woken with a simple tap on the head.

## Kano computer kit

Price: £149.99 / \$149.99 [kano.me](http://kano.me)

Building a computer is hard work - it involves learning how to make a circuit board and connect all the pieces together. This build-your-own computer set makes learning these new skills easy. Follow the book to build your own computer (and code it) step-by-step. When you're finished use your new computer to code pictures, build animations or create musical masterpieces.

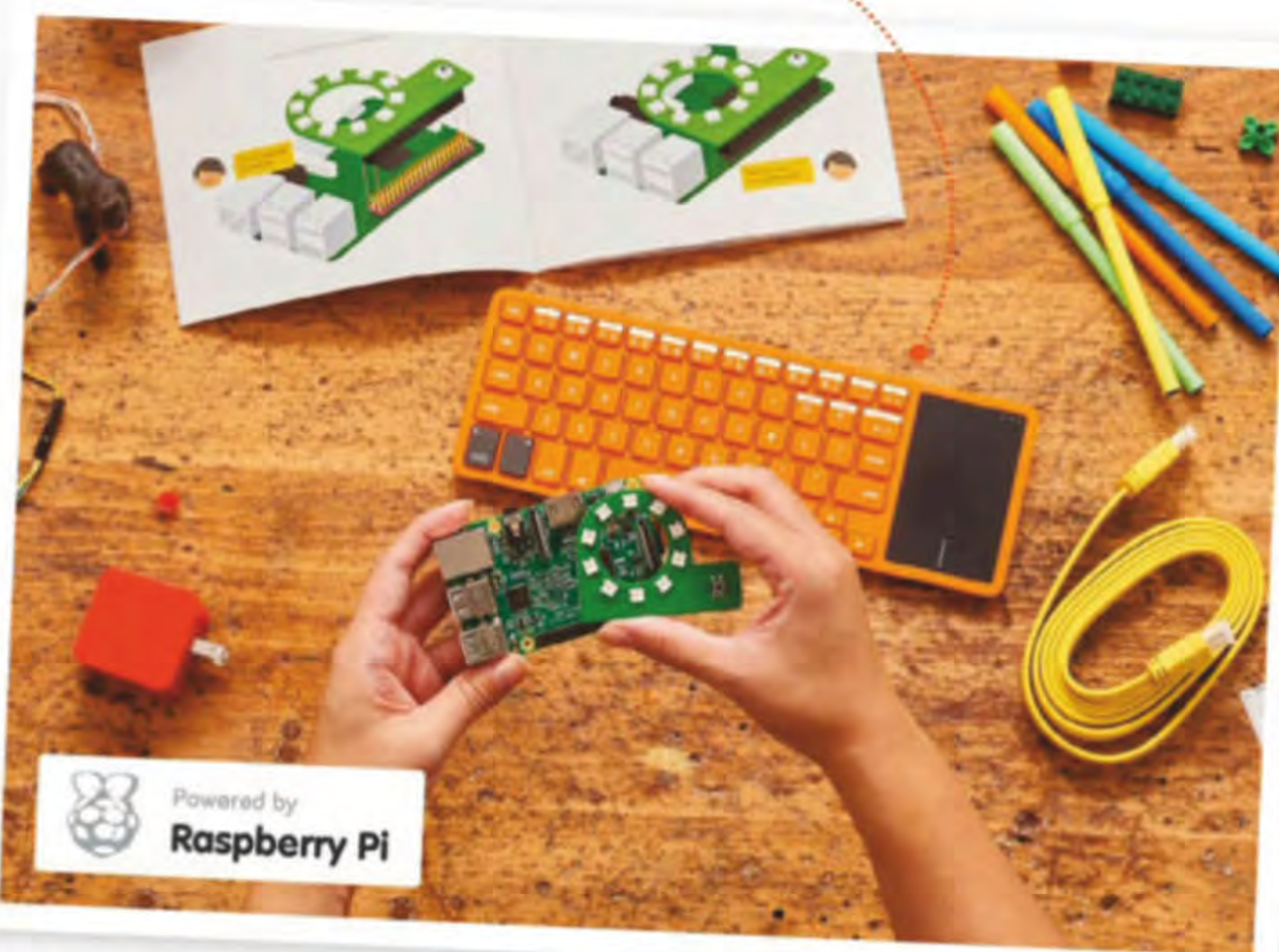

## Roli Songmaker kit

Price: £549.95 / \$649.95 [www.roli.com](http://www.roli.com)

Whether you're a future music producer or just an enthusiast, the Roli Songmaker Kit could be this year's must-have gadget for you. Roli has created several individual interchangeable blocks to act as a portal studio, allowing musicians to replicate sounds on their touchscreen-style design. These blocks are now available as kits, such as the Songmaker. This compact studio includes the super-powered keyboard, an LED-illuminated lightpad block and a loop block for further control. With the accompanying app and producing software, the Songmaker Kit is a great way to make your musical inspirations a reality.



## Light L16 camera

Price: £1,850 (approx. \$2,365) [www.light.co](http://www.light.co)

Though the Light L16 may appear to be a simple cross between a spider and a camera, this high-tech gadget is using its many eyes to produce stunning photography. Equipped with 16 lenses, this 52-megapixel camera has a 5x optical zoom ability. These 16 lenses work together, taking multiple images to produce the final combined image. Built-in auto-sensing technology means the L16 also adjusts its settings in response to light and camera stability automatically. Though it's bigger and heavier than a smartphone, the L16 is a much more compact piece of technology than traditional professional DSLR cameras.

has a 5x optical zoom ability. These 16 lenses work together, taking multiple images to produce the final combined image. Built-in auto-sensing technology means the L16 also adjusts its settings in response to light and camera stability automatically. Though it's bigger and heavier than a smartphone, the L16 is a much more compact piece of technology than traditional professional DSLR cameras.

## John Lewis & Partners 125 scientific challenge set

Price: £30 (approx. \$40) [www.johnlewis.com](http://www.johnlewis.com)

Are you up for a serious challenge? Then put your skills to the test with this fantastic STEM kit. Ideal for ages eight and up, this kit of 125 scientific challenges includes a buzz wire and an aim-and-shoot game to test your coordination. There's even some bubble science challenges and a moving dinosaur included.



## RED5 14-in-1 build-your-own solar robot

Price: £19.99 (approx. \$25) [www.johnlewis.com](http://www.johnlewis.com)

What's better than one robot? 14 robots. With this robot building set you can build up to 14 different types of robot, ones that can walk, roll, swim or float. The solar panel can be attached to a combination of plastic parts so you can be as creative as you want to be with your design. This introduction to solar technology is great for any budding scientist or engineer.

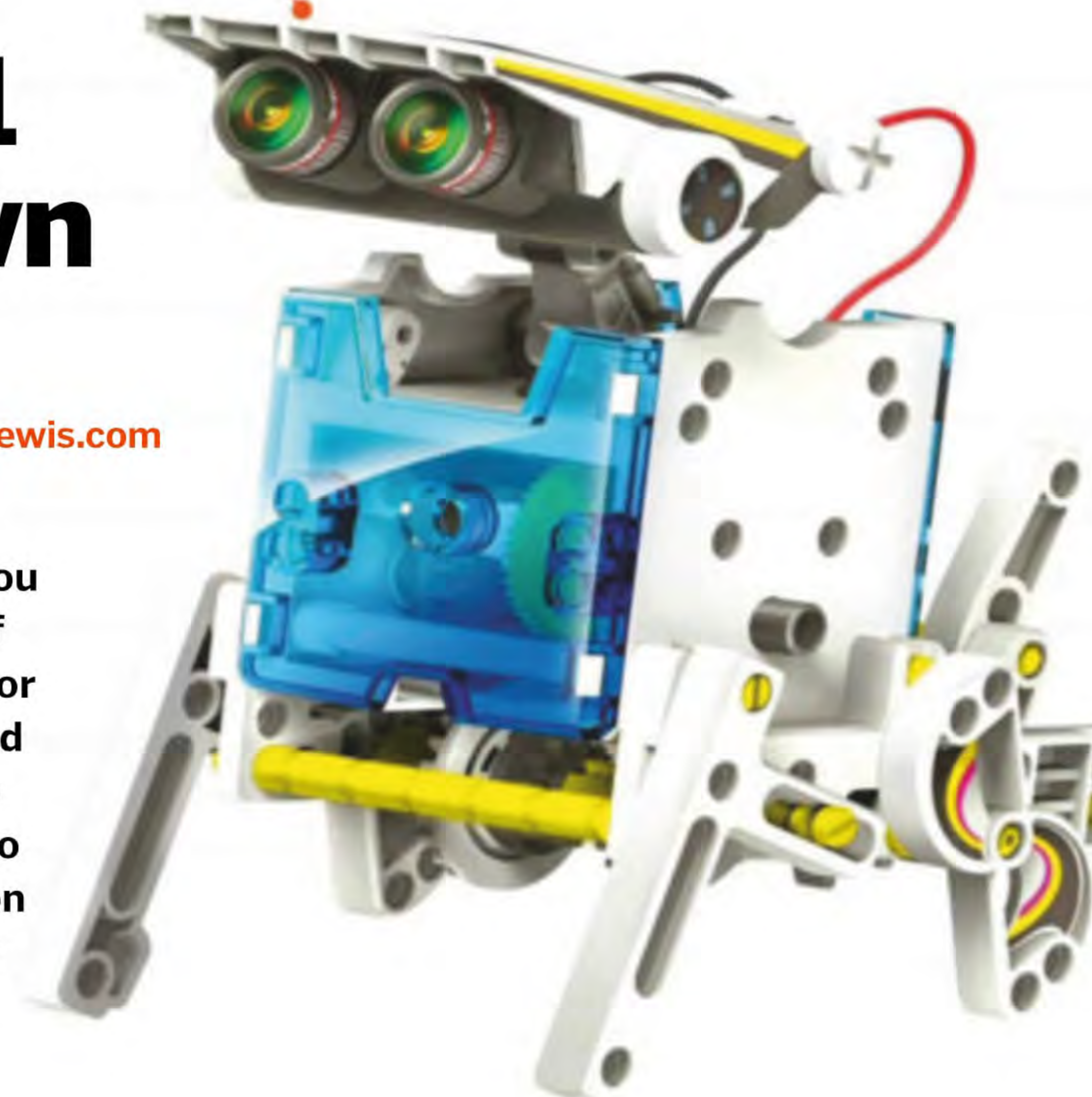

## APPS & GAMES

### Infinity Loop

Developer: InfinityGames.io  
Price: Free / Google Play / The App Store

This puzzle game forces you to read between the lines to form the hidden shape within. As the name suggests, you can create an endless range of different designs to unlock the next challenge.



### Leps by Fieldguide

Developer: Change Theory  
Price: Free / Google Play / The App Store

As the social media platform to share your butterfly and moth photographs, Leps can also suggest the identity of the species in your images.

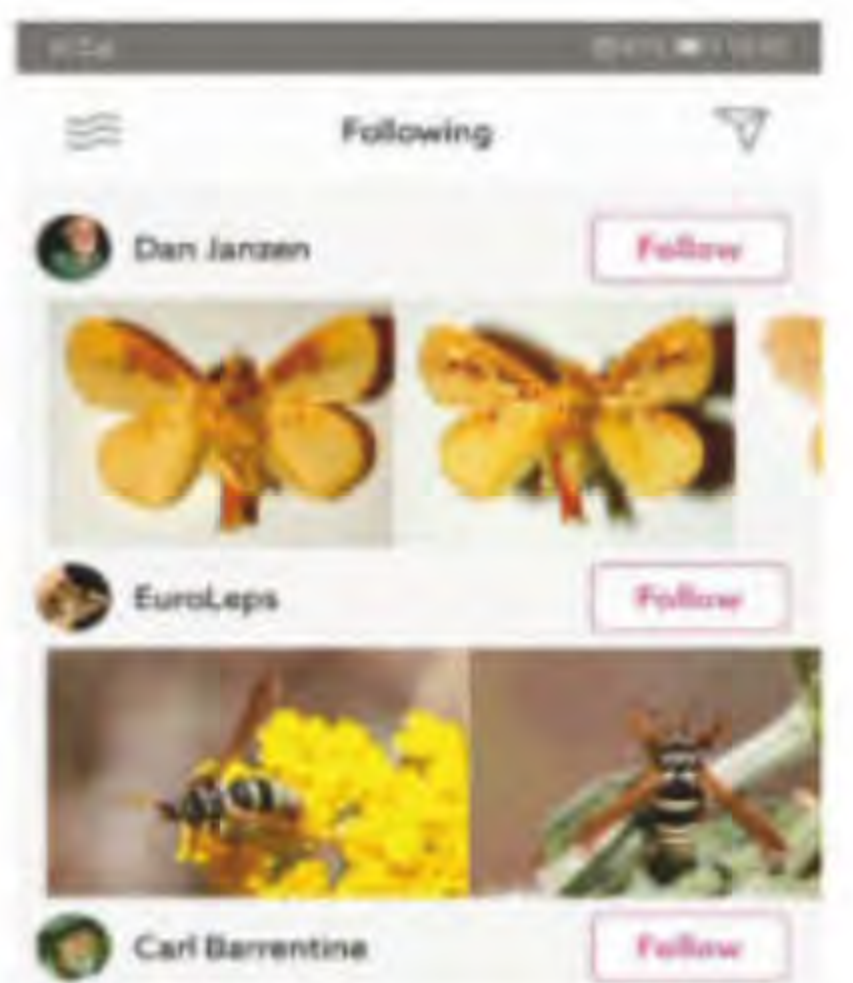

### BioBlox

Developer: Goldsmiths / Imperial College London  
Price: Free / Google Play / The App Store

Play and explore the world of protein docking using this Tetris-style game to learn how molecules of medicine and vitamins bind onto complex proteins of the body.



### acceleratAR

Developer: Cockcroft Institute / University of Liverpool  
Price: Free / Play Store

Build your virtual particle accelerator using some paper cubes and your smartphone and bring to life these amazing pieces of technology in your living room.

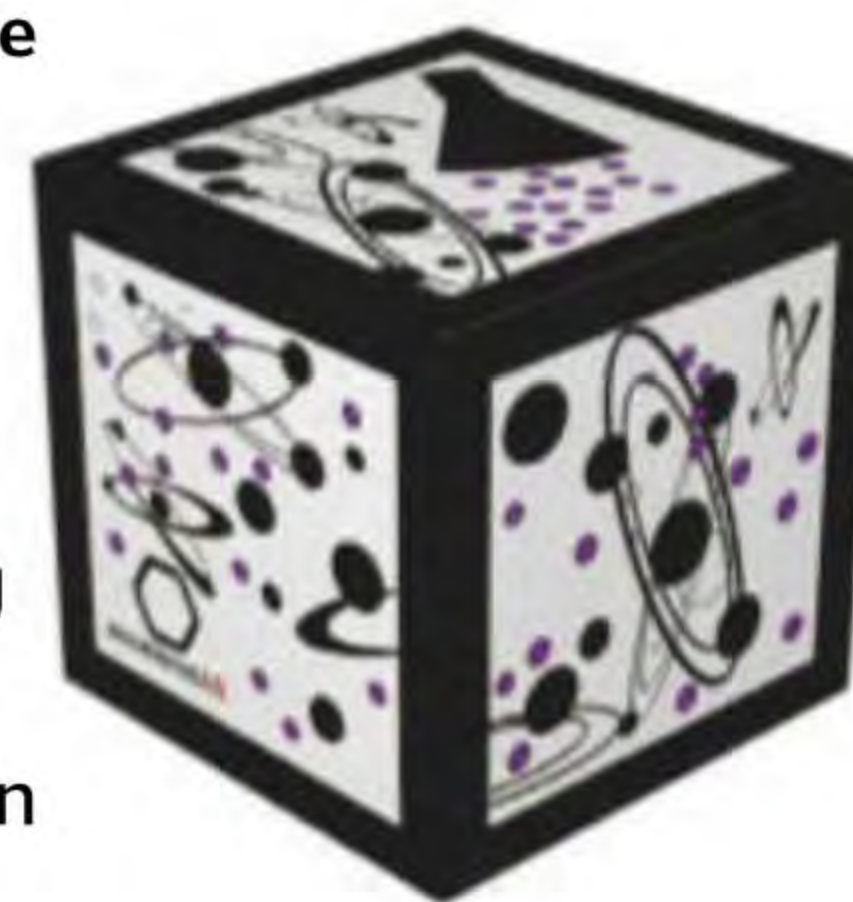

## Professor Jim Al-Khalili

AI has started to teach itself. Should we be worried about what the future holds?

**P**rofessor Jim Al-Khalili is a theoretical physicist, author and broadcaster. His BBC Four documentary *The Joy of AI* explores how machines have developed intelligence that can exceed the capacity of the human brain. In contrast to the apocalyptic hysteria of the press that warns of robots rising against their human creators, Professor Al-Khalili explains that AI has tremendous potential for humankind, from healthcare to climate change. The danger comes from who has control over the powerful technology and what they choose to do with it.

**There are intelligent machines everywhere we look in our everyday lives, from Siri and Alexa to the algorithms that predict the shows we would like on Netflix. What does 'artificial intelligence' actually mean?**

Artificial intelligence (AI) is intelligence that is not human or animal. We have created machines that can do something intelligently. When we think of intelligence, we usually mean something really clever, but AI is not necessarily that clever – it's just a machine that can do something that can mimic things; maybe tasks that humans do. What is exciting is that some AI is showing unexpected types of intelligence.

**What are some of these unexpected types of intelligence that we are seeing?**

You can play chess against a computer and we now know the best can beat even the best human opponent, even the grandmasters of chess. But to play chess a computer just has to be able to crunch through lots of numbers and possibilities – 'If I do this what will happen?' and it can work through billions and billions of combinations and then work out what the optimum thing is to do. It looks intelligent, but it is just number crunching. But now there are computer programs that are beginning to show intuition, almost like imagination. The AI company DeepMind produced AlphaGo and AlphaZero – both computer programs and they trained them on old 1980s Atari computer games, like *Asteroid* and *Space Invaders*. They don't have to give the AIs the rules of the game, they don't have to show them how to play, they just say watch this game and watch the patterns for



pixels figure out what you need to do. These AI can quickly figure it out and within a few hours can beat any human on Earth. They are figuring out new strategies that haven't even occurred to humans. That is quite exciting – they're starting to show real creativity.

**What is the smartest form of AI that we have available to us?**

The smartest AI we have is still pretty dumb by human standards. We use AI on our phones: Google Translate, Siri, Alexa. That's AI. It's listening to what you have to say and figuring out what it means and responding, but it is still doing it blindly. It's still a machine, it isn't conscious, it is not aware. The very best AI are able to search through patterns of data, or images for example, and pick out things that we can't spot as humans. For example, looking for very early cancer tumours in health care, they can spot cancerous cells in more detail and more quickly than a human can. So the smartest AI are the ones that are actually helping us do our jobs better.

**Are we going to see more of that in the future – AI having a role in healthcare and other industries to better society?**

Yes, it's inevitable. We have had the internet for 20 years, and the World Wide Web, and we look

back and think, 'How did we ever cope? What was the world like before the internet?' It's completely transformed our lives. I predict AI will do the same, and it won't need 25 years to revolutionise our daily lives as much as the internet has – it will do that in ten or 15. AI is coming, I'm certain of it. AI is going to be used in healthcare, finance, transport, environmental studies, research.

AI is going to be here whether we like it or not. But we have to remember that new science or tech is not necessarily good or evil, it's how we put it to use. An example is in the military. You could see the value of autonomous robots going in and doing bomb disposal or discovering landmines, because that is going to be a lot safer. But on the other hand autonomous killer drones can take the decision to take out humans... Machines killing humans, machines making the decision themselves: that's the sort of thing that is very scary and that is the sort of thing we need to have regulations against.

For me, the scariest thing is if we don't have that conversation and if the public are scared of AI, then there will be a backlash. They'll disengage and governments will see it as less of a priority. The tech won't slow down but it will be in the hands of big high tech companies, like Amazon and Facebook, or in the hands of cyber terrorists. Wider society needs to know what AI will be capable of so we can put the regulations in place, not to stop it but to make sure we're still in control of it.

**From a tech perspective what are the biggest challenges in progressive AI? Has it gone as far as it can possibly go or will it continue teaching itself?**

I think the tech is advancing a lot. There has been a massive increase in computing; there is more and more data available for AI to use and to be trained on. The idea of big data is something people find frightening – what does 'Big Brother' know about me? But that's what AI feeds on – it needs data.

There are new types of computer algorithms, which means AI is learning for itself and it's sort of writing its own code. That is exciting and new: it's learning the way we humans learn. If you look at a toddler or a baby, it looks around the

world and it sees its hand and picks things up. You learn from your environment all the time and life evolves and develops. Machines are developing learning.

I'm excited, it will change our lives. I'm not scared of AI, I'm scared that wider society isn't ready for it or doesn't appreciate how it might change the world.

**Are there particular regulations you would like to see or hope to see?**

There needs to be more broader regulations on what is done with our data. Healthcare is a good example. It's brilliant: we will have personalised medicine, so if you have a health problem, if your genome has been mapped, they can pinpoint exactly the right treatment for you. But who holds all of that information about you? What safeguards are there in place that stop it being used for other reasons if we just allow Amazon and Google and Facebook to have whatever data they want from us? Who knows what they will do with it.

Regulations on transparency, who controls the algorithms, what do you allow the AI to do: governments need to decide what we do – just like no chemist or biologist wants chemical or biological weapons. There are regulations and laws and treaties that stop most countries using them. It's not the fault of chemists and biologists if someone builds a weapon, the same way it's not the fault of a computer science or AI expert if someone uses AI like that, but we need laws and regulations in place to prevent that. It's not the AI you have to worry about, it is who controls it.

**Is there anything you want to see for yourself in AI?**

There are still mysteries out there that we humans with our puny human brains are unable to crack, so the big problems in physics, like what is dark matter, what is dark energy, what is the theory of everything, are there particles beyond the Higgs boson? Weirdly enough, AI might be able to help us solve those problems because sometimes some of these problems become so complex that a human can't literally get their head around the problem.

Solutions to climate change, population movements, how we utilise diminishing resources, water and food supplies. Those are big, complicated mathematical problems that require a lot of data, and AI might be able to make sense of it better than we can. That's where the power of AI comes in, and that's where it's really exciting.



Hanson Robotics' Sophia is the latest and most advanced robot in the world

*"I'm not scared of artificial intelligence, I'm scared that wider society isn't ready for it"*



AI might be used extensively in machines over the next few decades, from making medicine to music

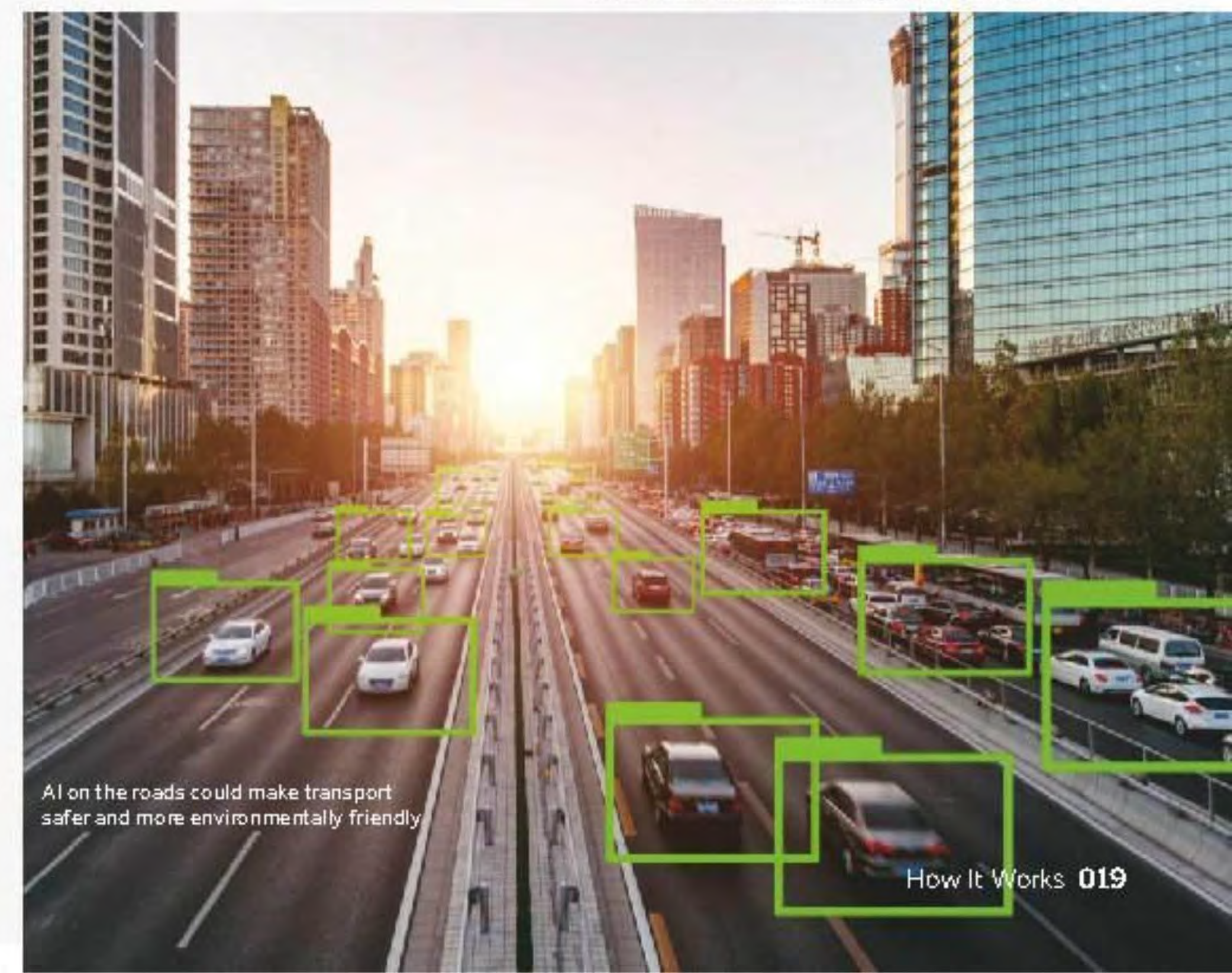

AI on the roads could make transport safer and more environmentally friendly

# EVERYTHING YOU NEED TO KNOW ABOUT THE WONDERFUL WORLD OF SCIENCE!

Delve into the discipline that aims to build and develop our knowledge of our world and beyond with the Book of Amazing Science! Complete with brilliant biology, curious chemistry and phenomenal physics.



# CORGI® Eddie Stobart



## A model delivery

Corgi's Eddie Stobart Collection is a series of quality die-cast and plastic 1:64 scale toy trucks suitable for children aged five and over. Each truck has a detachable trailer and carries an authentic livery of some of the most popular trucks on Britain's roads today.

AFTER WORKING WITH HIS FATHER IN Agriculture, Edward Stobart started his haulage career using his father's delivery trucks and formed Eddie Stobart Haulage Company in 1976. From this point, Edward was able to grow his business into Britain's most recognised haulier, employing over five thousand people.

Corgi is proud to present a range of fantastic Eddie Stobart models. Whether you are buying for a young collector starting out, or adding to your existing collection.

To order call **01843 233 512**

(Telephone order lines are open 9am-5pm Monday to Thursday and 9am-3pm on Friday)

Alternatively go to [www.corgi.co.uk](http://www.corgi.co.uk) or visit your local Corgi stockist!

YouTube /officialcorgi

@corgi

/corgidiecast

Eddie Stobart Ltd is a trademark used under license by Corgi.

Ordering is easy. Go online at: [www.myfavouritemagazines.co.uk](http://www.myfavouritemagazines.co.uk)  
Or get it from selected supermarkets & newsagents

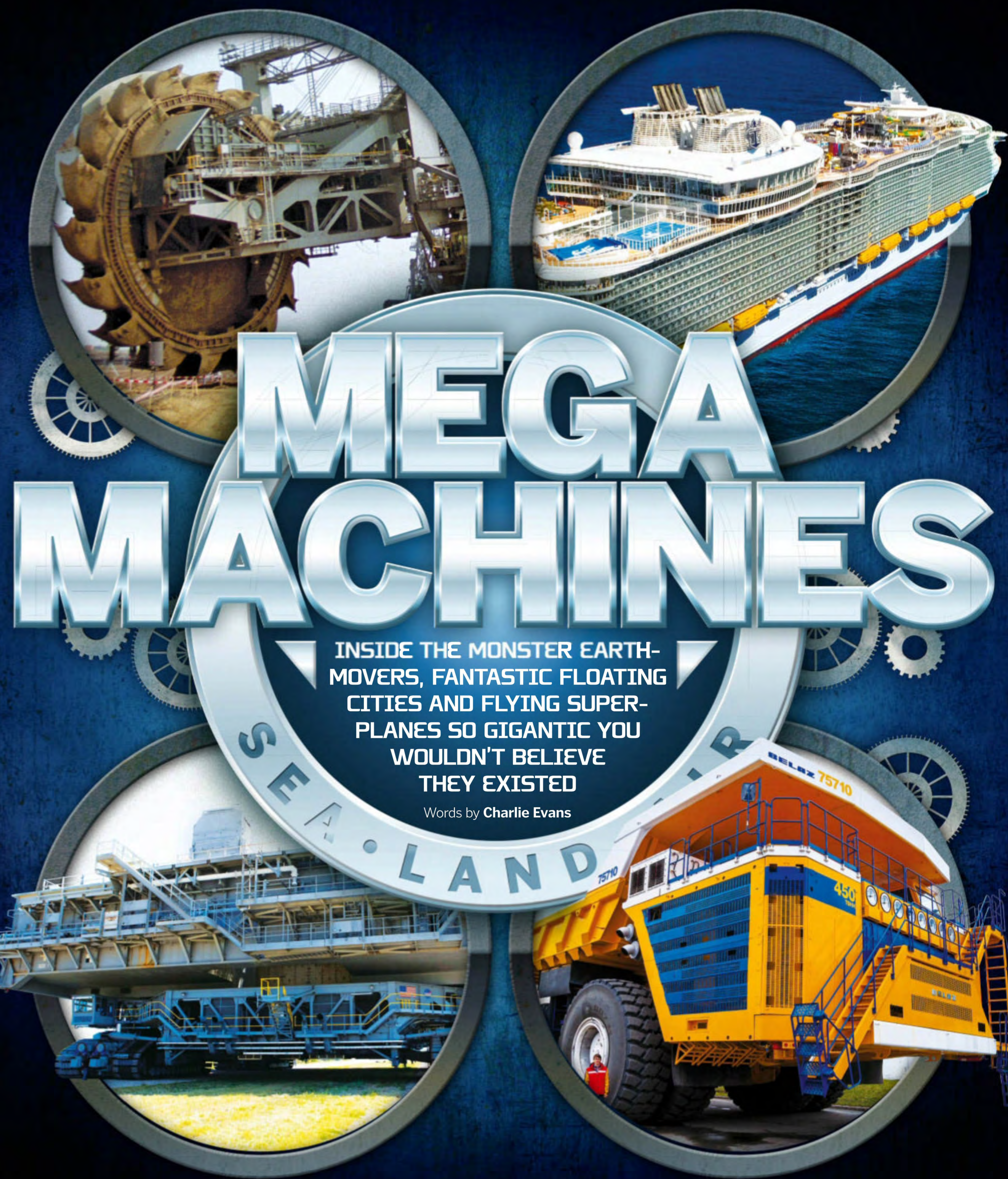

# MEGA MACHINES

INSIDE THE MONSTER EARTH-MOVERS, FANTASTIC FLOATING CITIES AND FLYING SUPER-PLANES SO GIGANTIC YOU WOULDN'T BELIEVE THEY EXISTED

Words by Charlie Evans

## Operating the Bagger 293

How this giant excavator leaves mountains of rubble in its wake

### BAGGER 293

#### Dimensions

220m long

94.5m tall

#### Weight

14,196tn

#### Capacity

218,880 tons of soil per day

### Conveyor belt system

Kilometres of conveyor belts feed through the machine to gather the coal and transport it from the site to be loaded onto trains.

### Rotating wheel

A 21m-diameter wheel rotates the buckets to pick up rock and drop it onto the conveyor belt below.

### 18 buckets

Each of the 18 buckets on the machine has a volume of 6,600L, moving 240,000m<sup>3</sup> of earth in a single day.

### Caterpillar tracks

The mighty machine moves along on caterpillar tracks with a top speed of around 0.53km/h.

### Crew

A crew of five are required to operate the Bagger 293. They can find themselves walking as far as 9.7km a day in the process of crewing this mega mining machine.

The Bagger 293 is currently being used in a mine near Hambach, west Germany

## PIT-MINING JUGGERNAUT

The Bagger 293 excavator is the world's largest land vehicle

Its incredible size and jagged-edged wheel makes the Bagger 293 look like something looming on the horizon of a post-apocalyptic nightmare. But what looks like an intimidating circular saw is actually composed of giant buckets designed to scoop earth as the wheel revolves and digs.

Baggers are a series of bucket-wheel excavators that operate in large, open mining pits. They are able to move thousands of tons of material every day, and when used with other

machinery, such as conveyor belts and crushing systems, they act as some of the most efficient earth-moving machines in operation in the world today.

The Bagger 293 is the biggest of these monster machines. Based in Germany, it holds the record for the largest and heaviest land vehicle in the world. It weighs as much as 2,000 adult elephants and is as tall as a 30-storey building. Astonishingly, it can dig a hole the length and width of a football field to a depth of over 25

metres in just one day. The highly efficient machine alone extracts enough coal to power the homes of several million people.

They're mostly commonly used in brown coal (a softer type of coal made of naturally compressed peat) mining as an alternative to blasting. Instead, they scrape away at the soft rock to expose the harder rock that lies beneath before getting to work on extracting the coal. When they're in action the result is literally earth-shaking.



# BIG BUCKET DUMPER

The BelAZ 75710 is the world's largest and highest-payload-capacity dump truck

**BELAZ 75710** Designed and built by Belarusian automobile engineering company BelAZ to transport rocks in mines and tackle tough terrain in challenging weather, the BelAZ 75710 is a far cry from the usual dumptrucks you see on the roads. The vehicle even earned a spot in the *Guinness Book of Records* for its giant size.

Although the basic design sticks with the conventional two-axle setup, the wheels are doubled. The BelAZ 75710 boasts eight 59/80R63 tyres as well as four-wheel drive and four-wheel hydraulic steering. These features give the mega machine an incredible turning radius of about 20 metres. The 8.165-metre-high and 9.87-metre-wide 75710 can carry about 450 metric tons in one go, but it isn't just this mega machine's size that gives it monster dumptruck status. It's also powerful, hosting not one but two MTU 65-litre, 16-cylinder, four-stroke diesel engines that drives the vehicle at an impressive maximum speed of 64 kilometres per hour.



# BEHEMOTH ROCKET TRANSPORT

How NASA's crawler-transporters move towering rockets from the hanger to the launchpad

**CRAWLER**  
Dimensions  
40 x 35m  
6.1-7.9m high (adjustable)  
Weight  
2,721tn

**Operator cabs**  
Two cabs, one at each end of the vehicle, are used to control all of the crawler's systems.

**Giant tracks**  
The crawlers move on eight treads, two per corner, with each tread containing 57 shoes, each of which is 2.3m long and 0.5m wide.



## Crawler-transporter technology

Renovation and redesign has sparked new life into old crawler-transporters

**DID YOU KNOW?** The crawler-transporters consume 350 litres of fuel per kilometre and its tanks hold 19,000 litres

There are many challenges when launching a rocket, many of which happen long before reaching the stratosphere. One of these is moving the rocket from the assembly point to its launch pad. This mammoth task is carried out by twin mega machines – the NASA crawler-transporters. It is their job to move rockets from NASA's Vehicle Assembly Building along the Crawlerway to Launch Complex 39, and they have been used for Apollo and Space Shuttle missions. The transporters were designed and built in 1965 by the Marion Power Shovel Company using components developed by Rockwell International. 50 years later, rockets are being designed that are much bigger and heavier than the original Saturn V moon

rockets the crawlers were crafted to shift. As a result, although they remain the largest self-powered land vehicles in the world, the crawlers are in need of an upgrade. Both machines have already received modifications, including replacing the existing bearings of CT2 with redesigned traction roller assemblies ready to support SLS and Orion. Using these modified crawlers NASA plans to send astronauts further than ever before -

first to an asteroid and then on to the surface of Mars.

The upgrades have seen the crawlers' lift-load capacity increase from 5.4 million kilograms to 8.2 million kilograms, ensuring the crawler-transporters still have a future supporting NASA missions and will continue to push the boundaries of space exploration for another 20 years.

The full, awesome scale of a crawler in action as it delivers a rocket to its launchpad for take off



**Top deck**  
The top deck that carries the rockets is flat and square and about the size of a baseball infield.

**Megawatt power**  
Both crawlers have 16 traction motors, powered by four 1,000kW generators, and are driven by two 2050kW diesel engines.

## Mega machines in space

While the teams working on the crawler-transporters get to work on the upgrades, rockets themselves are getting much bigger. A bigger size means a greater supply of fuel (enabling longer and faster journeys) and more capacity to transport goods into space. SpaceX currently has the biggest and most powerful rocket – the Falcon Heavy. This partially reusable heavy-lift rocket towers at 70 metres and has twice the payload capacity of its nearest competitor. The Falcon Heavy made its maiden flight in February 2018, and there are more planned this year.



The Falcon Heavy weighs almost as much as three Falcon 9s together

**Laser docking**  
In 1985 a laser docking system was added to the crawlers, allowing them to dock within 0.635cm to 1.25cm of the fixed position at the launch pad.

**Jacking, equalising and levelling (JEL) system**  
Monitored and controlled from inside the crawler's control room, the JEL system keeps the upper deck and pick-up points level to prevent its rocket payload from toppling.

The OOCL Hong Kong has a gross tonnage of 210,890 tons



The Hong Kong's sister ships are called Japan, Indonesia, Germany, United Kingdom and Scandinavia

### Formidable freighters

These ocean-going mammoths can transport incredible loads

- OOCL HONG KONG**  
 Dimensions 399.9m  
 Weight 191,317tn
- MADRID MAERSK**  
 Dimensions 399m  
 Weight 210,019tn
- MOL TRIUMPH**  
 Dimensions 400m  
 Weight 192,672tn
- BARZAN**  
 Dimensions 400m  
 Weight 199,744tn
- MSC OSCAR**  
 Dimensions 395.4m  
 Weight 197,362tn
- CSCL GLOBE**  
 Dimensions 399.7m  
 Weight 184,320tn
- MAERSK 'EEE'**  
 Dimensions 399.2m  
 Weight 194,153tn

## WORLD'S BIGGEST CONTAINER SHIP

The awe-inspiring OOCL Hong Kong is the first of a new breed of container ship

Passenger ships may have become a thing of luxury and leisure rather than necessity, but cargo vessels remain a vital lifeline transporting more and more goods around the world as our population booms. The largest of these cargo ships has been constructed by South Korean shipbuilder Samsung Heavy Industries, which has started to build six G-class container ships for Hong Kong-based shipping company Orient Overseas Container Line (OOCL). The first of these ships, stacked with brightly coloured containers, will now be undertaking a 77-day round trip to north Europe from Shanghai via the Suez, stopping at ports from Rotterdam to Singapore before returning to Shanghai.

In May 2017 the Hong Kong OOCL was the first to be delivered of the new ships. At

almost half a kilometre long, the ship would tower over London's skyline if it was stood upright and would stand taller than the Shard and Canary Wharf. It has been built with a two-stroke, in-line, 11-cylinder MAN Diesel & Turbo (MDT) G-type engines to power the ship at a maximum speed of 21 knots. While this speed is only about four times as fast as a swimming crocodile, it's an impressive feat considering the ship is hauling over 20,000 containers.

Equipment installed onboard Hong Kong OOCL includes a pair of combined electrically driven mooring winches to keep the ship safely docked and high-tech real-time propeller analytics.

**OOCL HONG KONG**  
 Dimensions 399.9m long  
 Weight 191,317tn

*"The ship will undertake a 77-day round trip to northern Europe from Shanghai via the Suez"*

DID YOU KNOW? Operating over 250,000 kilometres of track, the US railway network is the largest in the world

## FLOATING CITY

The Symphony of the Seas is the largest cruise liner ever built

The MS Harmony of the Seas is an Oasis-class cruise ship delivered to Royal Caribbean International in 2016. Everything from the onboard entertainment to the design of the vessel is about luxury. The ship comes complete with a theatre, surf simulators and 23 swimming pools. Until recently, Harmony of the Seas was unrivalled in the cruise industry: then her bigger sister, Symphony of the Seas, was christened in November 2018.

The new ship is almost as long as the Empire State Building is tall and includes

facilities such as a water park, an ice rink and two rock-climbing walls. There is even a slide that children can use to go from their bedrooms to the living area and a bar that serves drinks with a robotic arm.

Constructing this enormous vessel took three years, but now the Symphony crosses the Caribbean with room for an incredible 5,518 passengers in 2,759 stateroom cabins as well as a crew of 2,200.



**SYMPHONY OF THE SEAS**  
 Dimensions 362m long  
 72.5m high  
 18 decks  
 Weight 228,081tn

The Symphony of the Seas cost \$1.35 billion to build



The Ghan's journey takes 54 hours, including a four-hour stop in Alice Springs

### The longest passenger train

The Ghan is one of the world's longest passenger trains. Consisting of 44 carriages and two locomotives, the titanic train is over one kilometre long. Hosting the Ghan is an impressive 2,979 kilometres railway that bisects Australia. Running from Adelaide in the south to Darwin in the north, the route connects both sides of the country for the first time and travels at an average speed of 85 kilometres per hour. It took nearly three years to complete and the Ghan embarked on its first journey in February 2004.



© Royal Caribbean International, Alamy, Getty, Illustration by Ed Crooks

# GIANT SKY LAUNCHER

The impressively winged Stratolaunch is designed to take space rockets into the skies

## STRATOLAUNCH

**Dimensions**  
117m wingspan  
**Weight**  
589.67tn (max launch)

Mega machines have conquered land and the sea, but it will still be some time before we see them in our skies. The first planned mega-plane will be the Stratolaunch. Designed to overcome the challenges of flying through the dense lower atmosphere, the Stratolaunch will launch rockets from runways rather than pads.

Prior to his death in October 2018, billionaire founder of Stratolaunch Paul

Allen had ambitious dreams of making launching rockets into space as easy as catching a commercial plane to go on holiday. The idea is that a rocket will be carried by the Stratolaunch to altitude, where the rocket will ignite its own engines, blasting it into space. This would mean that launches could happen on any giant runway, rather than having to carefully time a launch in accordance to the Earth's rotation and the desired position in space.

When the Stratolaunch is completed it will be the largest airplane by wingspan ever created. The twin-fuselage catamaran-shaped aircraft will have six Pratt & Whitney turbofan jet engines, which are used by Boeing 747s. The right-hand fuselage is the one with a cockpit, and the other is so far away that from the window it looks like a separate plane parked in the hanger. At the moment the plane is going through testing both on and off ground.

It is expected that the Stratolaunch will make its first flight in 2019, and it will soon be working alongside other companies to aid in launches and deliveries.

When the Stratolaunch is completed it will be the largest airplane by wingspan ever

## Stratolaunch technology

How the Stratolaunch will transport three air launch vehicles, each carrying a 453-kilogram satellite into low Earth orbit

### Dual fuselage

A dual fuselage provides enough room inside the plane to carry multiple giant payloads into space.

### High wing design

The giant high wing design allows launch vehicles to be released from the aircraft centreline for safe deployment.

### Engines

Six Pratt & Whitney PW4056 thrust-range jet engines sourced from used 747s power the Stratolaunch into the air.

## Giant flying machines

The biggest commercial plane is the Airbus A380. So far, 232 of these impressive, double-deck, wide-body, four-engine jet airliners have been built. Until the Stratolaunch is completed, the Airbus A380 sets the record of having the largest wingspan - approximately 15 per cent larger than the Boeing 747. The plane can seat up to 853 people, and has a cruising speed of about 1,050 kilometres per hour. The Airbus is the first commercial airliner to have a central wing box made of carbon fibre reinforced plastic and a smoothly contoured wing cross section to reduce aerodynamic drag.



### Centre wing

The reinforced centre wing provides lift and stability to support the weight of the launch vehicles.

### Wingspan

The wingspan is the largest of any plane, with a width longer than an American football field.

### 3 Launch

Once it reaches the correct altitude the Stratolaunch will release the rocket.

### Cockpit

The cockpit features the same pedals, steering and altitude- and speed-monitoring systems used on commercial planes.

### 2 Up and away

The Stratolaunch will take the rocket to an altitude of 35,000ft.

### 1 Take off

The Stratolaunch will use liquid oxygen and hydrogen as fuel to generate a thrust of 90,720kg-force.

### 4 Return flight

With its load now on its way into space, the Stratolaunch will return to base.

## Aerial launch

How the Stratolaunch will propel rockets into space like never before

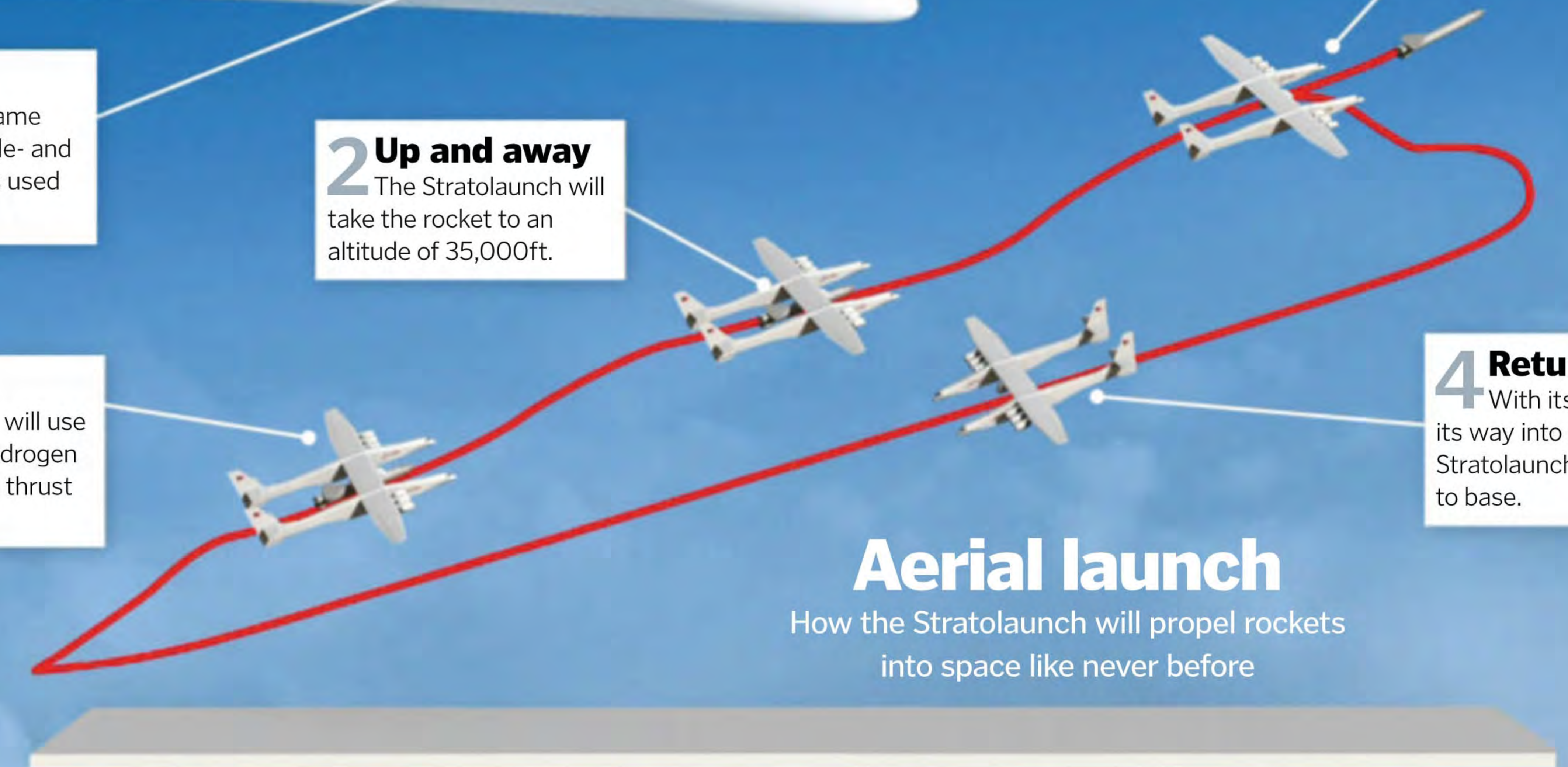

The largest plane you will see in the sky at the moment will be the Airbus A380



# How they crash-test cars

Welcome to Ford's state-of-the-art car safety testing facility

In 2018, car manufacturer Ford opened the doors of its new €15.5-million (around £14-million / \$17-million) testing facility in Cologne, Germany. This facility has the capacity to carry out up to four crash tests per day, and the new sled-test system is by far one of the most impressive pieces of technology Ford is using to test car passenger safety.

Sled tests are a way to reproduce a high-speed collision in a controlled environment. The car compartment that typically holds passengers is mounted on a trackway, then a connected hydraulically powered propulsion system launches the compartment backwards along the track. In the case of Ford's new system, that's a propulsion force equivalent to 250 tons, 80 times the force of gravity experienced in typical road collisions.

Within the compartment are high-tech dummies equipped with around 70 sensors including accelerometers, each recording impact data for engineers to later analyse. Accelerometers record the speed and direction the various sites on the dummies' bodies travel during a crash. This information is then used to develop the interior features of the car, such as seat belts and airbags. At different

points of the dummies' faces strips of paint are applied, which during the simulated crash transfer onto deployed airbags. This provides an imprint on the deployed bag and information about their effectiveness.

"Full-scale crash tests give us a wealth of information but they take longer to set up," explained Stephan Knack, head of the Ford Crash Test facility. "Virtual crash tests are fast but [they are] not yet as reliable as the real thing. Our new sled test bridges the gap between the real and the virtual worlds, so that we can deliver improvements faster, resulting in safer vehicles."



Test dummies come in all shapes and sizes, simulating different body types and ages of passengers

**DID YOU KNOW?** In the early years of crash testing cadavers, pigs and chimpanzees (and other animals) were used!

## The dummies that save lives

Sled tests are used to test the physical effects of a high-speed collision on passengers' bodies using high-tech dummies

### Big impact

Experiencing an acceleration of around 80 times the force of gravity, crash dummies have inbuilt sensors and accelerometers to record their movements during the test.

### Lights, camera

High-powered lights surround the sled test to ensure the clarity of the images from the high-speed cameras.

## Head-on collision

Despite its many advantages, what the sled test can't do is test the effects of a crash upon the entire car. This is where the full-scale head-on crash test comes in. While these tests are another way to study the effects on the passengers during a crash, a head-on collision test monitors the effect a crash can have on the car itself. Hurling down the runway at a speed of 50 kilometres per hour, the front of the new Ford Focus crumples as it collides with a reinforced wall. During the collision cameras are used to capture the impact frame by frame at around 1,000 frames per second.



### Primed to crash

A replica passenger compartment is attached to a hydraulically powered propulsion system.

## Autonomous reactions

Though sled tests and test crashes are integral to ensuring the safety of passengers in the event of a collision, preventative technologies could be the future for safety on the roads. Ford have stepped road safety up a gear with their latest Ford Focus. By incorporating autonomous safety features, including Adaptive Cruise Control (ACC), the new Focus can assume control of the wheel to avoid an accident. Situated around the exterior of the car's body, three radars, two cameras and 12 ultrasonic sensors enable the Focus to continually monitor the road around it. While set in ACC the car assesses the distance between itself and other cars. When it senses a sudden reduction in speed, the ACC will adapt the car's speed to prevent a collision. This is also the case should a pedestrian appear in the road suddenly: without the need for reaction from the driver, the exterior sensors alert the car to the pedestrian's presence and automatically carry out an emergency brake.



The latest Ford Focus can respond to passing vehicles and people autonomously with its 'Stop and Go' feature

### Catching the crash

High-speed cameras record the sled test at a rate of 1,000 frames per second, allowing engineers to evaluate the airbag and seat belt timings.

# SUBSCRIBE

to **How It Works** and get a Powerball Supernova Pro\*

## The ultimate fitness gadget!

Experience stunning icy-blue LEDs powered by a super-spinning rotor as you develop the strength and dexterity of your fingers

**FREE GIFT**  
worth  
**£24.99**



### FASTER THAN AN F1 ENGINE

Computer-balanced rotor is vibration free to 15,000rpm+.

### GO SUPERNOVA!

Includes 6 induction-powered blue and white LEDs.

### COMPACT TECHNOLOGY

Includes multi-function LCD counter to record spin speed (Pro model).

### CHALLENGE YOUR STRENGTH

Produces 0-35lb of inertial resistance powered just by your wrist.



## WHY SUBSCRIBE?

- Brilliant value – save money on the cover price
- You'll never miss an issue
- It's delivered direct to your door



**Subscribe now**  
[www.myfavouritemagazine.co.uk/hiw/121m](http://www.myfavouritemagazine.co.uk/hiw/121m)  
or call 0344 848 2852 & quote HIW121M

**PRINT**  
Six-month subscription to **How It Works** in print, plus a Powerball Supernova

**£26**

**PRINT & DIGITAL**  
Six-month subscription to **How It Works** in print & digital, plus a Powerball Supernova

**£35**

\*Terms and conditions: This offer entitles new UK Direct Debit subscribers to pay just £26.00 every 6 months plus receive a Powerball Supernova. Gift is only available for new UK subscribers. Gift is subject to availability. Please allow up to 60 days for the delivery of your gift. In the event of stocks being exhausted we reserve the right to replace with items of similar value. Prices and savings quoted are compared to buying full-priced print issues. You will receive 13 issues in a year. Your subscription is for the minimum term specified. You can write to us or call us to cancel your subscription within 14 days of purchase. Payment is non-refundable after the 14-day cancellation period unless exceptional circumstances apply. Your statutory rights are not affected. Prices correct at point of print and subject to change. UK calls will cost the same as other standard fixed-line numbers (starting 01 or 02) or are included as part of any inclusive or free minutes allowances (if offered by your phone tariff). For full terms and conditions please visit: [www.btlv/magterms](http://www.btlv/magterms). Offer ends 21 February 2019. Direct Debit Originator's reference 768195

# ELECTROMAGNETISM EXPLAINED

When scientists started playing with 'electric fire' it changed the world forever

Words by Laura Mears

In 1752, as the sky darkened across Philadelphia, Benjamin Franklin went outside with a silk kite. He tied a length of wire to the top point and two strings to the bottom, one hemp and one silk. Sheltering from the storm as he worked, Franklin attached a metal key to the hemp string, now wet with rain. He kept a tight hold of the dry silk string and, as the kite struggled into the air, his experiment began.

Soaring between the lightning strikes, the wet kite started to conduct electricity from the atmosphere. Electric fire, as Franklin called it, passed down the wet hemp and into the key, sending sparks to his fingers. He gathered the charge inside a 'battery' called a Leyden jar, catching electricity from the air.

This wasn't the first time people had played with sparks. In 1663, Otto von Guericke had rubbed spheres of sulphur to produce a static charge, and in the early-18th century Stephen

Gray had sent electricity coursing along hemp threads and metal wires by rubbing glass tubes. Even so, Franklin's kite was a catalyst for science that would change the world.

Spurred on by the sparking kite, experimenters set about turning observations into equations. The first mathematical explanations of electricity emerged later that century. Charles-Augustin de Coulomb realised that electrical and magnetic forces worked a bit like gravity – the closer you got to the source, the stronger they were. Later, Alessandro Volta invented a chemical battery by layering copper, zinc and brine-soaked cardboard. This allowed Georg Simon Ohm to start testing which materials could conduct a current. He used his

observations to develop a law that explains how the length and diameter of a material affect its resistance to the flow of electricity.

Advances were coming thick and fast, but something was missing. No one had realised that electricity and magnetism were linked. Then, in 1820, Danish physicist Hans Christian Ørsted accidentally filled in the missing piece. He noticed that a flowing current could move the needle of a compass – it made a magnetic field. Michael Faraday then observed the reverse – a moving magnetic field made electrical currents flow.

Armed with these facts, James Clerk Maxwell went on to explain electromagnetism to the world, paving the way for the electronic revolution.

*"Spurred on by the sparking kite, experimenters set about turning observations into equations"*

## Anatomy of an electromagnetic wave

There are two parts to every wave – an electric field and a magnetic field

### Wavelength

The distance between waves can be smaller than the width of an atom or wider than the Earth.

### Magnetic field

The magnetic field oscillates at 90° to the electric field – they travel at right angles.

### Electric field

The electric field oscillates in phase with the magnetic field – they go up and down together.

### Direction of propagation

The two parts of the electromagnetic wave travel in the same direction.

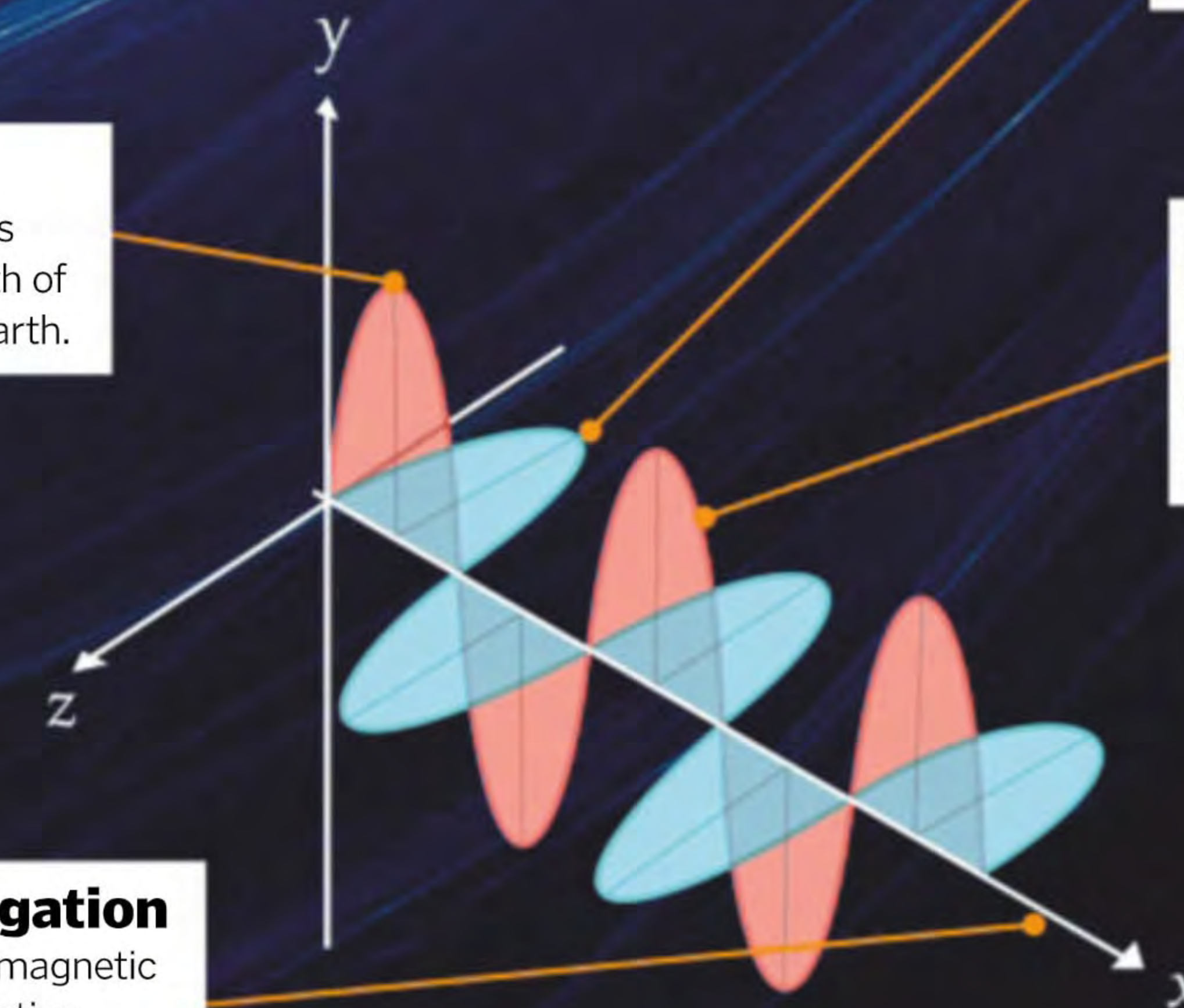

## The father of electromagnetism

James Clerk Maxwell's four equations changed the world. The first two – Gauss' Law and Gauss' Magnetism Law – explain how electricity and magnetism move. Matter can have a positive or negative electric charge, and the flow of an electric field through a surface is proportional to the charge within that surface. But there is no equivalent magnetic charge. Magnets always have both a north and a south pole, so the flow of a magnetic field through a surface is zero. The third and fourth equations explain how electricity and magnetism interact. Faraday's Law states that a changing magnetic field induces a current, while Ampere's Law states that a flowing electric current creates a magnetic field. All four together describe how electricity and magnetism work.



James Clerk Maxwell unified the fields of electricity and magnetism

# FARADAY'S LAW

In the early-19th century a British physicist made a breakthrough

Michael Faraday discovered that magnetic fields could induce electric currents. Scientists already knew that the opposite was true – electric currents produce magnetic fields. In 1820, physicist Hans Christian Ørsted had been setting up a lecture demonstration when he accidentally put a live wire near a compass. To his surprise, the magnetic needle moved. Soon after, France's André-Marie Ampère explained why.

With a set of parallel wires, Ampère showed that live currents could attract and repel. When the currents ran in the same direction, the wires pulled together. When they ran in opposite directions, they pushed apart. Using these observations he worked out that the attraction between the wires was proportional to the current they carried and the length of the wires (Ampère's Law).

With Ampère's observations in hand, people realised they could amplify magnetic fields by wrapping coils of wire together. This led to the invention of the electromagnet by William Sturgeon in 1825. We could now generate powerful magnetic fields using

electricity. All that remained was to show that this could happen in reverse.

To do this, Faraday wrapped two coils of wire around a ring of iron, one on each side. To the first he connected a battery, to the second a compass. The two coils were independent – the current from the battery couldn't reach the compass needle and neither could the magnetic field induced in the first wire, but, when he switched the battery on, the compass needle moved anyway. Rather than moving the compass needle directly, as in Ørsted's experiments, the magnetic field from the first wire was inducing a current in the second wire. The induced current was moving the compass. This was the first demonstration of electromagnetic induction.

Later experiments confirmed that any changes to a magnetic field can generate a voltage. You could move or rotate a magnet inside a coil, move or rotate a coil inside a magnetic field, or vary the strength of the magnetic field itself. If the coil is part of a complete circuit the voltage sets off a current.

## How motors work

An alternating current turns a coil of wire inside a static magnet

### Current

The current travels through the wires to the electric terminals.

### Commutator

This split metal ring turns as the coil spins, periodically reversing the direction of the current.

### Magnet

A static magnet sits around the outside of the motor, creating a steady magnetic field.

### Brushes

Brushes connect the wires to a rotating structure called the commutator.

### Coil

When a current flows through the coil it induces a magnetic field around the wire.

### Magnetic field

Changing the direction of the current flips the magnetic field induced in the coil, making it spin.

## Creating currents

The science behind electromagnetism

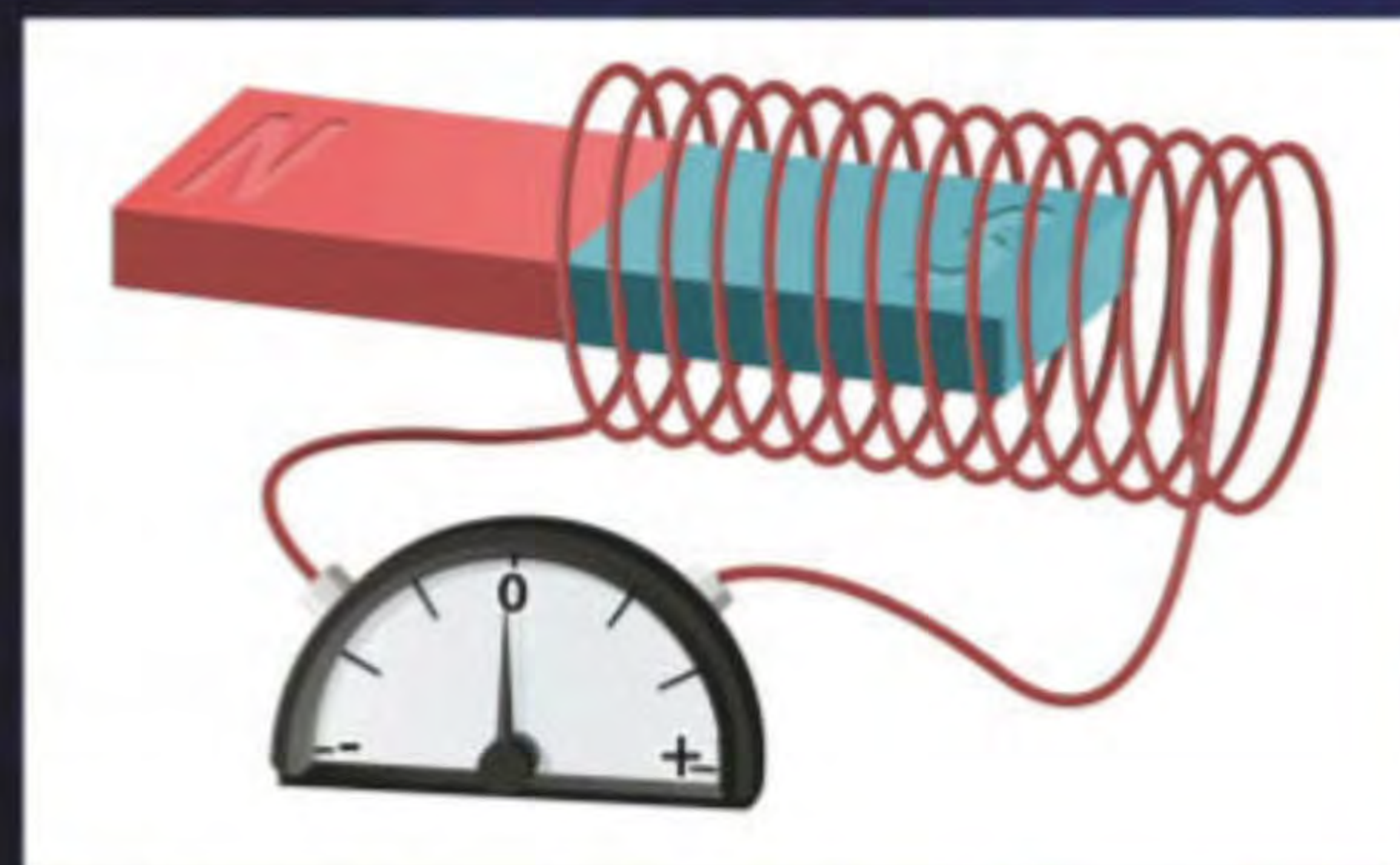

**1 No flow**  
When both the bar magnet and the coil of wire are still no current flows.

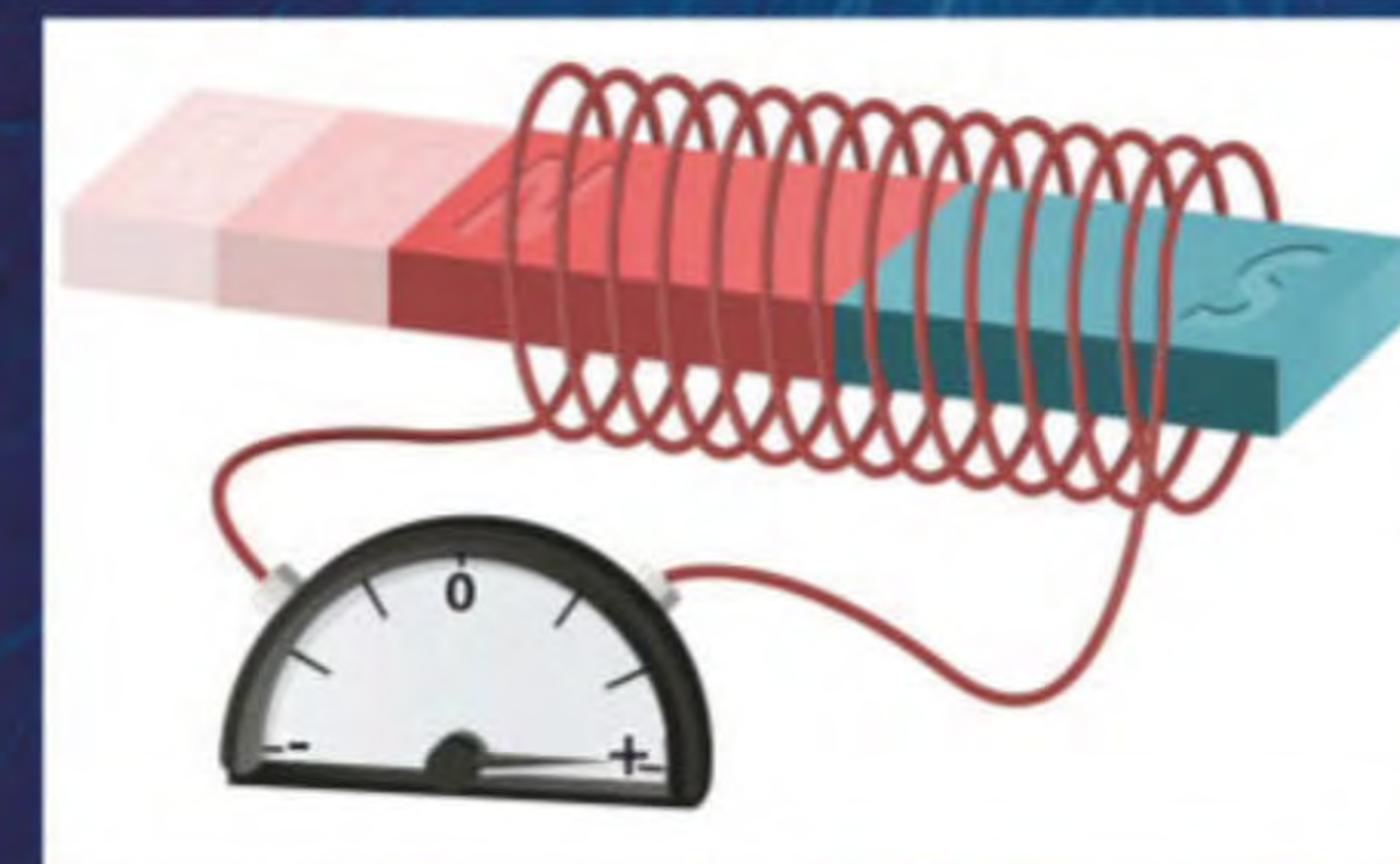

**2 Sparking to life**  
Pushing the magnet into the coil moves the magnetic field, inducing a current in the wire.

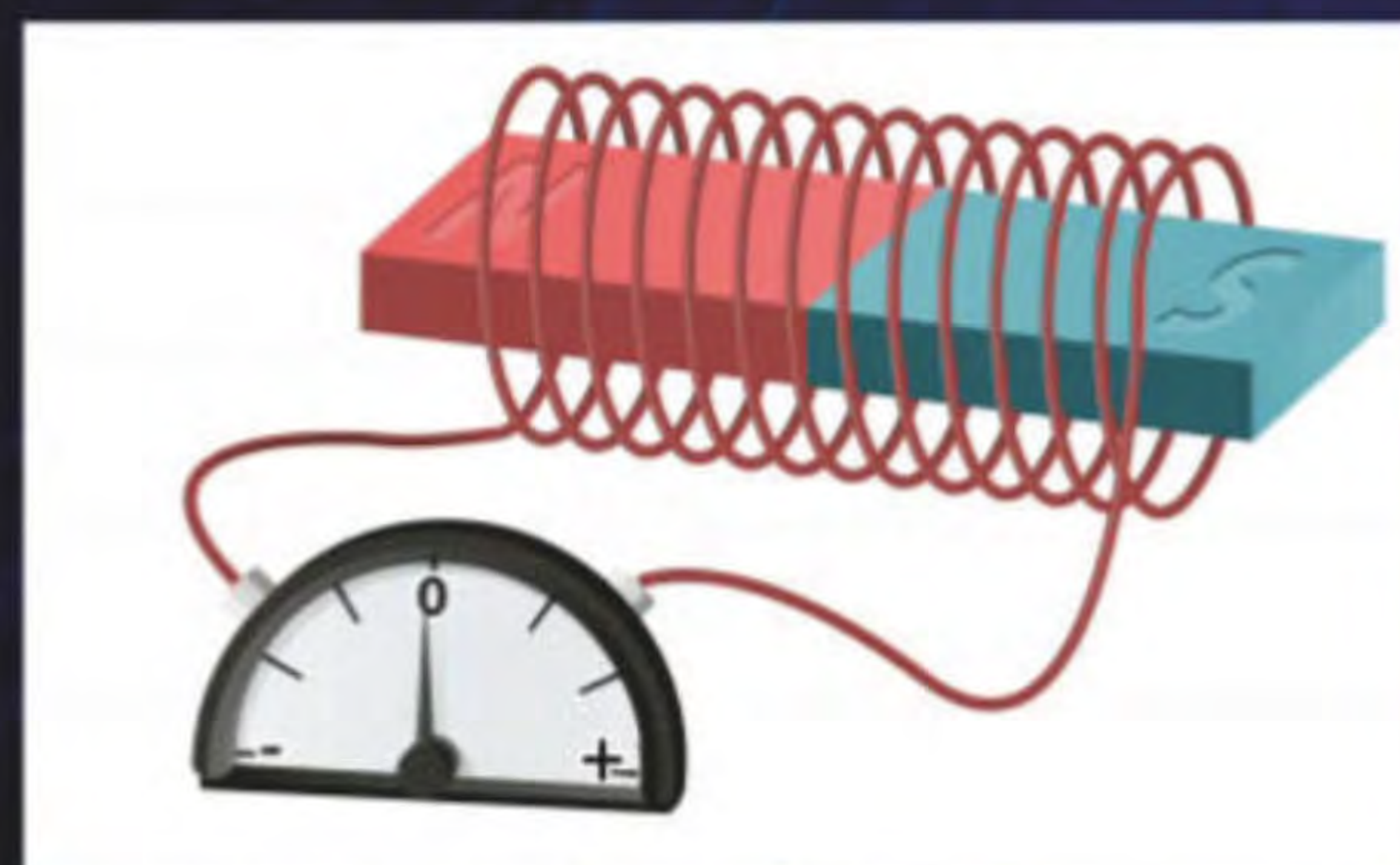

**3 Stopping the current**  
When the magnet stops moving the induced current goes away again.

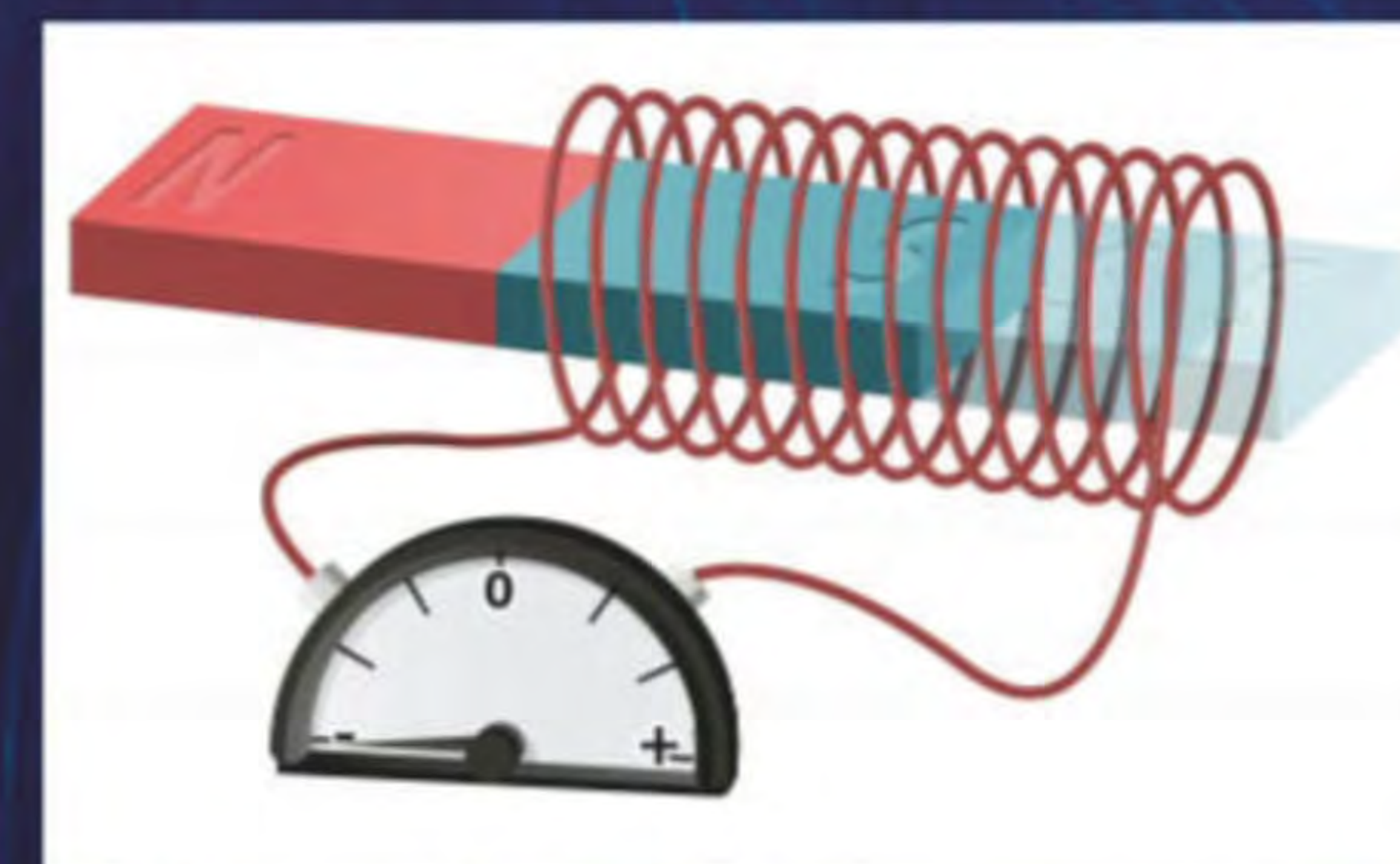

**4 A new direction**  
Removing the magnet from the coil induces a current in the opposite direction.

### Battery

The battery provides a direct current that flows constantly in one direction.

Coils of copper wire generate magnetic fields that make this electric motor spin



*"People realised that they could amplify magnetic fields by wrapping coils of wire"*

This simple hand trick shows which way a wire will move in a magnetic field

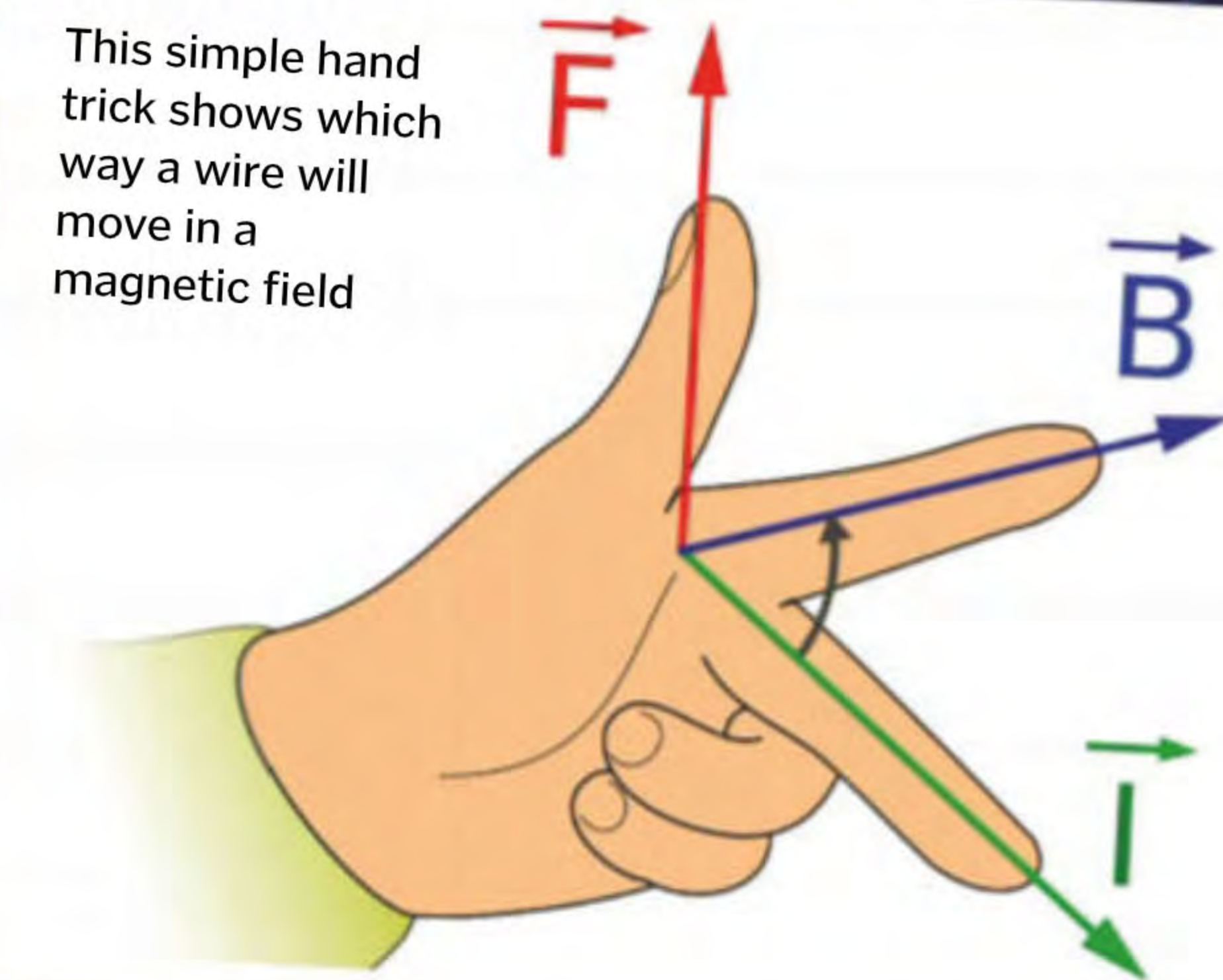

## Fleming's left-hand rule

When electrons move through a wire they generate a magnetic field that circles the wire like a corkscrew. Imagine applying another magnetic field across the wire. The lines of the external field try to travel from one side to the other, but they interact with the corkscrew in the middle. One field attracts or repels the other and the force makes the wire jump. Sir John Ambrose Fleming invented a rule to predict the direction of this movement. Hold out your left hand with your index finger forward, your second finger down and your thumb sticking out to the side. Point your second finger in the direction of the flowing current and your first finger in the direction of the external magnetic field. Your thumb will show you the direction that the wire will move.

The electromagnetic revolution illuminated Earth, changing the world forever



# SEARCHING FOR INVISIBLE LIGHT

It wasn't until the 1800s that we started to look beyond the light we can see

The discovery of the electromagnetic spectrum began with William Herschel, who used prisms to break light into rainbows. In a bid to understand each colour's temperature he measured each ray with a thermometer and noticed something strange. Moving the thermometer into the darkness beyond the red edge of the rainbow increased the temperature. He'd discovered infrared light.

Fascinated by this finding, Johann Wilhelm Ritter tested the other end of the rainbow. The wavelengths at the blue end of the spectrum are cooler, so instead of using a thermometer he chose a chemical called silver chloride. He knew it turned black in the light and that the effects were faster as the light became more purple, and, just as Herschel had noticed with his thermometer,

the effect continued when the rainbow ran out. Ritter had discovered ultraviolet light. Inspired by this work, James Clerk Maxwell predicted there would be more wavelengths beyond the rainbow. Heinrich Hertz designed a piece of equipment called a spark-gap transmitter to find them. He wrapped two insulated coils of wire around some iron, one loose and one tight. When a current passed

through the loose coil it magnetised the iron. Then he stopped the current and the magnetic field faded, inducing a large voltage in the second coil. Hertz attached the second coil to copper wires separated by a small gap, and whenever the large voltage came a spark would jump from one side to the other. A metre and a half away he set up a rectangle of copper wire with another spark gap. He noticed that when the first gap sparked, the second gap sparked too – the current created radio waves that travelled across the room. Hertz also experimented with microwaves. Wilhelm Conrad Röntgen was the next to make a breakthrough. He was experimenting with a piece of kit called a vacuum tube,

which has an anode and a cathode inside an enclosed container. He happened to have a screen in his lab coated in a fluorescent chemical called barium platinocyanide. He noticed that even if he covered the vacuum tubes and worked in the dark the screen would glow when he switched the current on. When he asked his wife to put her hand between the tube and the screen it created a perfect image of her bones – the first X-ray. Soon after, while investigating the radiation emanating from radium, Paul Villard discovered gamma rays, completing the electromagnetic spectrum.



Wilhelm Röntgen's wife, Anna Bertha Ludwig, was the first person ever to have an X-ray



Industrial electromagnets use Ørsted's science to lift scrap metal with electricity

### Gamma rays

The highest-energy electromagnetic waves are the gamma rays. Like both ultraviolet light and X-rays, they count as 'ionising radiation'. When they hit molecules they can knock electrons away, creating reactive ions that can damage cells and tissues. We can harness this power to treat certain types of cancer.



- + HARMS CANCER CELLS. KILLS BACTERIA.
- CAUSES CANCER. BURNS THE SKIN.

### X-rays

X-rays are more powerful than ultraviolet light and their wavelengths are shorter. This allows them to travel through the human body rather than just into the skin. Different materials absorb different amounts of energy, revealing bone and metal on X-ray images, but prolonged exposure can cause harm.



- + TRAVELS THROUGH THE BODY. SCANS INSIDE OBJECTS.
- CAUSES CANCER. CAN'T SHOW FINE DETAIL.

### Infrared light

This type of radiation transmits heat across the universe. It interacts with chemical bonds, increasing their energy level and heating them up. We use it to cook our food and heat our homes and for thermal imaging. It can also transmit information over short distances, including using a television remote control to change the channel.



- + TRANSMITS HEAT. EMITTED BY ALL OBJECTS.
- CAUSES BURNS. ABSORBED RAPIDLY.



### Ultraviolet light

As we move into the higher-energy part of the spectrum the radiation gets more dangerous. Ultraviolet light can damage molecules like DNA and collagen, causing sunburn, skin ageing and skin cancer. But we can also put UV light to good use – it kills bacteria and makes fluorescent materials glow.



- + KILLS BACTERIA. EXCITES FLUORESCENT MATERIALS.
- DAMAGES THE SKIN. CAUSES CANCER.

### Visible light

Not only does visible light allow us to see and make sense of the world around us, but we can also use it for long-distance communication in fibre optics. Visible light zips through glass cables across long distances, allowing lightning-fast information transfer.



- + DETECTABLE BY THE EYES. TRAVELS THROUGH GLASS.
- SMALL PART OF THE SPECTRUM. DAMAGES THE EYES.

### Microwaves

Like radio waves, microwaves can store and send information. We use them for mobile phone communications and to talk to satellites. They also interact with the water in food and drink, transferring energy and heating the molecules – this is the technology behind microwave ovens.



- + CARRIES DATA. PASSES THROUGH ATMOSPHERE.
- CAUSES BURNS. SUPERHEATS WATER.

### Radio waves

Radio transmitters send out signals called continuous sine waves. By changing the amplitude or frequency these sine waves can carry patterns of information through the air. When they hit an antenna they induce an electric current with the same patterns, thereby passing the message along.



- + TRAVELS LONG DISTANCES. DOESN'T HARM THE BODY.
- LIMITED DATA STORAGE. ATMOSPHERIC CONDITIONS CAN INTERFERE WITH SIGNAL.

# The chemistry of cleaning

How we use simple science to clean items in our homes and workplaces

If you've ever washed a frying pan and become frustrated with the stubborn oily residue left behind or seen mould growing in the cracks of the kitchen tap, you know that cleaning is far more complex than giving things a lazy wipe with a cloth. The trick to cleaning effectively usually requires a combination of chemical degradation of molecules, mechanical force and rinsing to remove the dirt from the item.

Dirt comes in three broad categories: organic, inorganic and combination. Organic soils include everything from a biological source, such as grease, mould and food products. Inorganic soils include rust (which builds up when air and water react together) and minerals such as sand, silt and clay.

Most organic soils are best removed by alkaline cleaners or solvents, which work by breaking down the grease or fats, making them easier to remove by scrubbing, while inorganic soils are best tackled with acids. Acid-based sprays are most commonly used in cleaning baths, sinks and taps, where their corrosive effects will dissolve the dirt but leave the surface materials unaffected.

Specialised cleaning products, like stain remover and bleach, use various chemicals designed with this chemistry in mind. These products are applied with equipment like sponges and cloths. Together, they are the best way to keep your home free from mould, harmful bacteria and other nasties that grow in the time it takes to pile up the dirty dishes.



Cleaning products have become an essential in everyday life

## Regular soap vs antimicrobial soap

You might have noticed that some products, including laundry detergent and hand soap, are described as 'antimicrobial'. They claim to be able to kill germs to keep you safer from the microscopic monsters, rather than just detaching them from the surface you are cleaning. While they use chemicals like chlorine or alcohol, which are certainly great at killing microbes, research has shown that washing your hands with antibacterials is probably no better than regular soap. Thorough hand washing is more than enough to remove dirt and germs, and with an increasing concern for antibacterial resistance, it's good to hold off on the harsher antimicrobials.



Soap and water is always the best way to wash your hands, but if you don't have access to water then antibacterial gel can be helpful



### Organic stain remover

These chemicals, usually hydrogen peroxide, break down colour-causing molecules and are effective when the item is washed at a temperature higher than 40°C. Hydrogen peroxide needs to mix with tetraacetylenediamine to work at lower temperatures.



### Scourer

Usually with one soft side and one rougher side, scouring pads are designed to mechanically remove dirt using friction to break the particles loose.



### Dry cleaning clothes

Dry-cleaning shops use chemical solvents other than water to wash delicate clothing and textiles that would be damaged in a washing machine or dryer.

*"The trick to cleaning effectively usually requires a combination of chemical degradation of molecules, mechanical force and rinsing to remove the dirt from the item"*



### Dish detergent

Detergents use chemicals called surfactants that allow water to penetrate grease and separate the particles, making it easier to loosen the dirt from your plate.



### Pressure washer

This uses a powerful jet of water under high pressure. It effectively blasts dirt off sturdy surfaces like paths and walls and washes it away.



### Bleach

This cleaner is great at tackling colourful stains. The chemicals in bleach release oxygen molecules in a process called oxidation, which break up the chromophores responsible for the colouring.

Tickling can help to strengthen social bonds between family members

# Why tickling makes us laugh

How this strange reaction is a human evolution that kept our species safe

**B**eneath your skin are millions and millions of nerve endings – branched arrangements of white-coloured cells that send signals to your brain. They're telling your brain that the label of your jumper is digging into your back and that the paper between your fingertips feels smooth. When these nerves are touched lightly they stimulate two regions of the brain: the somatosensory cortex, which analyses the sensation, and the anterior cingulate cortex, which processes pleasant feelings.

If someone brushes a feather against your skin, both of these areas of the brain burst into action and you experience the feeling of tickling. This experience makes us laugh, but not because we find it funny. It appears that what

we're actually doing is showing that we are not a threat to the aggressor (in this example, the person with the feather). Think about the places on your body that are most ticklish – usually it's the neck, armpits and feet.

Humans are a social species who live in groups so they are able to pass knowledge from one generation to another and across individuals. When our ancestors engaged in tickling the aggressor was teaching the other person how to defend themselves. If you imagine someone coming to tickle you on your sides, you would probably clamp your arms down to protect yourself. Evolutionary biologists expect that tickling is a form of harmless attack on others in our social group. Making another laugh involuntarily is a display of dominance.

## Why can't you tickle yourself?

Try tickling yourself. Aim for somewhere you know you are usually quite ticklish, like the back of the neck. You won't get the same response of laughter as if someone else had tickled you. When neurologists have compared fMRI scans of people who are being tickled to others trying to tickle themselves they have seen a marked difference in the activity of the tickle regions. The response in the somatosensory cortex and anterior cingulate cortex is dulled when people try to tickle themselves. Studies at University College London have demonstrated that the cerebellum, a part of the brain which monitors movements, can predict your own movement. So it uses this prediction to cancel the familiar response of the brain's other tickle regions to the tickle. As a result, we remain calm rather than experience the laughter in response to being tickled.



You can trick your brain by using a feather, but most people still can't tickle themselves

## Why are some people more ticklish than others?

For some people tickling is funny, for others it's painful or unpleasant, while some people are not ticklish at all. Scientists are unsure why people experience the sensation differently but expect it may be a result of genetics making some people's skin more sensitive. They do know that you are more likely to be ticklish if the tickling catches you by surprise or if it is a close friend doing the tickling. In 2016, a study in rats revealed that anxiety made them less responsive to tickling, which might also be true in humans.



Tickles from a relative cause a bigger response than from someone you don't know well

ADVERTISE  
HERE TODAY



Want to advertise in our fact-packed science and technology magazine?  
Call now on 01225 687368 or 01225 687374.  
Find out more about advertising with Future on [www.futureplc.com](http://www.futureplc.com).

HOW IT WORKS

techcamp.org.uk

Inspiring Tomorrow's Inventors



Easter Camp Bookings Open!

EXCLUSIVE NEW COURSES ...

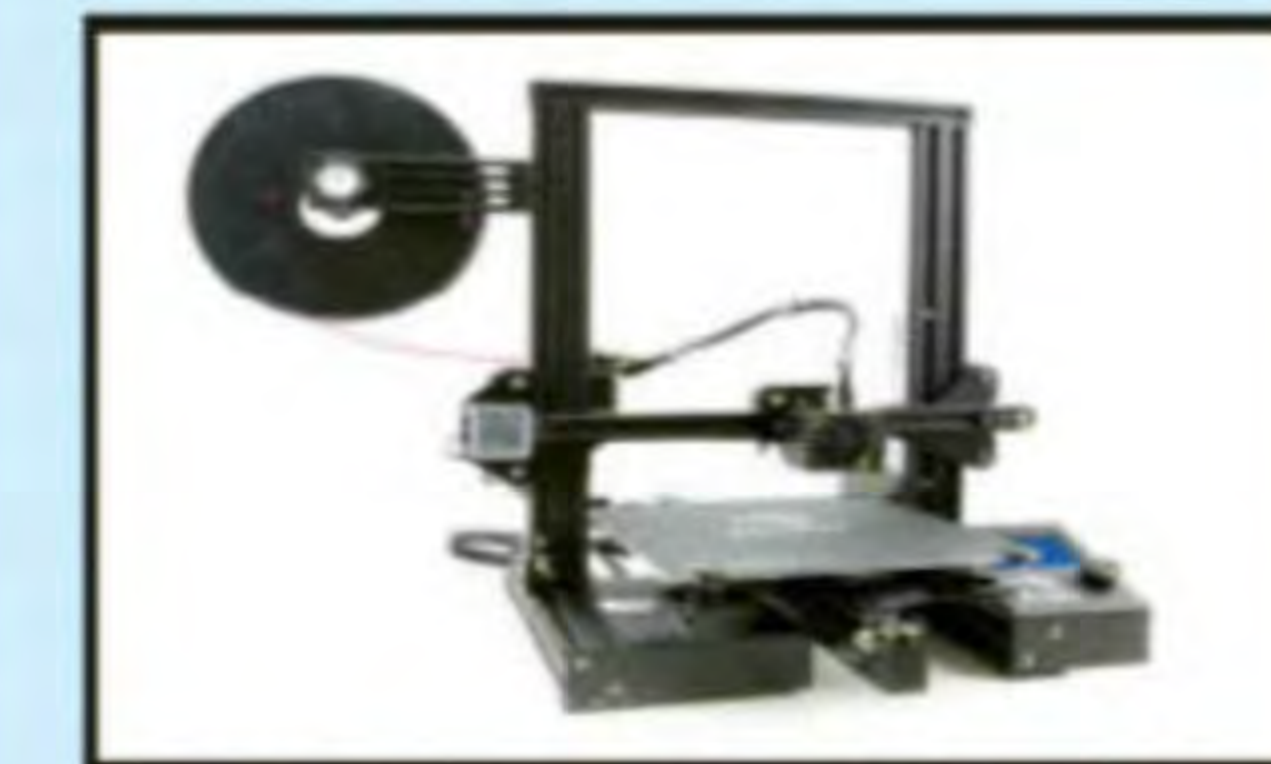

Build your own 3D printer to take home and learn 3D design in  
**3D Printing**

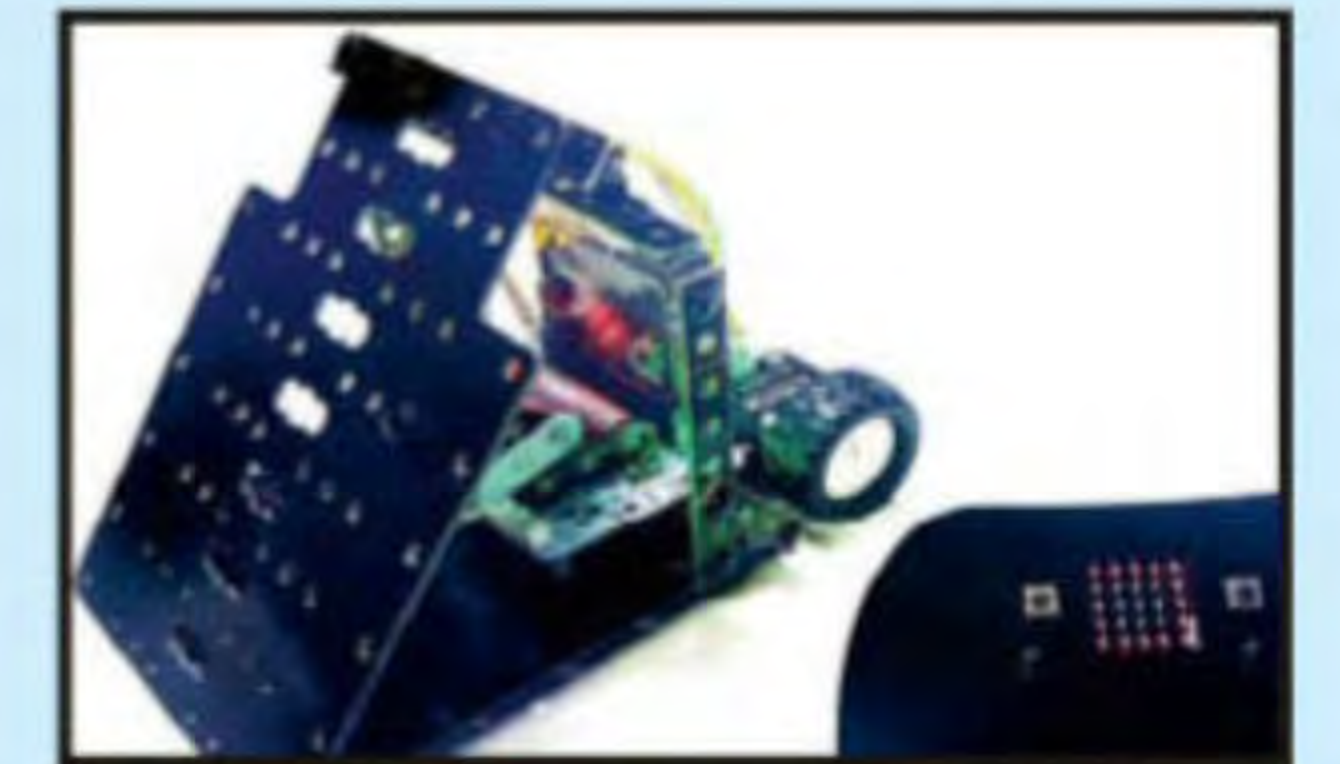

Build & programme advanced robots with flippers & optical cannons in  
**Robowars**



Build & race FPV drones & build a programmable LED race hoop in  
**Drone Racing**



Create a sophisticated 3D game with the 'Unity' Game Engine in  
**3D Game Design**



Learn about codes, build spy gadgets and explore cybersecurity in  
**Cyberspy Academy**



Build a number of 2D games, and learn graphic and sound design in  
**2D Game Design**

Come as a day camper at one of our three venues in the South of England, or join hundreds of other young people from around the UK and overseas at our flagship residential camps where you also spend evenings playing laser tag, learning extreme soldering and disassembling electronics.

## Want to Know More?

Tech Camp is the UK's original camp of its kind and remains the only one specialising in teaching coding through advanced take-home projects. It's perfect for creative youngsters who like making things (or taking them apart!) or show those who are forever playing games how to start designing their own.

We have tutors from institutions like Cambridge & Imperial, maximum groups of eight, and exclusive courses not available anywhere else.

[www.techcamp.org.uk](http://www.techcamp.org.uk) [info@techcamp.org.uk](mailto:info@techcamp.org.uk) 0118 380 5678



**DID YOU KNOW?** The world's largest raptor is the Andean condor, with a wingspan of 3.2 metres



# HOW BIRDS OF PREY HUNT

What makes these raptors some of the planet's most prolific predators?

Words by **Scott Dutfield**

**C**ircling the skies, the wings of a raptor gently ride the wind, eyes locked on the ground below. When the opportunity presents itself, a graceful display turns to a dramatic dive to the ground. Talons extended, the raptor reaches for its meal, delivering a fatal blow as it lands. As predators go, they are some of the most efficient and well adapted our world has to offer. Currently, there are 557 species that are classed as a bird of prey. From the mighty golden eagle to the humble barn owl, these birds are perfectly equipped to form a taxonomical group of deadly hunters.

The commonly used name of 'raptor' covers two types of birds of prey: the Falconiformes and

the Strigiformes. The former includes the majority of predatory birds that hunt in the day, such as hawks and eagles, whereas Strigiformes are mostly nocturnal predators, such as owls. What unites them is their ability to utilise their defining physiology to hunt from the skies. But what actually makes these birds such formidable predators?

## **TALENTED TALONS**

One of the most qualifying features of a bird of prey are a set of intimidating toenails. As a resourceful predator, raptors come equipped with razor-sharp talons to hook into their prey, tearing flesh as they go. However, they are more



Bald eagles prey on fish, small birds and rodents

than just a simple set of knives; eagles, for example, have impressively tailored talons to suit their feeding habits. Typically, eagles and many other raptors have three forward-facing toes and one facing back, perfect for gripping prey such as mice or rabbits. The grey-headed eagle, however, feeds on fish and therefore has evolved two toes facing forward and backward. This enables them to snatch at the scales of a slippery fish. Not all birds of prey need talons with a vice-like grip. When prey is already dead there is no need to have feet capable of holding them still, something the vulture has become accustomed to. Their feet are more suited to standing for long periods of time, enabling them to scavenge on the remains of a previous kill.

**HAWK-EYED**

Soaring high in the sky, raptors use their excellent vision in order to spot their next meal. It's believed that some can spy medium-sized prey from up to 1.6 kilometres away. This impressive sight is the result of binocular vision. The eyes of most other species of birds are on either side of their head, but raptors have forward-facing vision. This allows them to focus in on their prey while retaining a 340-degree field of view.

Humans typically have 20/20 vision, meaning they can see clearly at 20 feet (6.1 metres) what should normally be seen at 20 feet. Raptors such



The eyesight of a raptor is around eight times better than that of a human

as hawks, however, sport 20/5 vision, allowing them to see something at 20 feet that a human would typically see at five feet (1.5 metres). Being able to spot prey at this distance puts raptors at a huge advantage while hunting. Though we typically recognise a circling raptor as being on the hunt, this impressive eyesight allows some birds to target their prey from the comfort of a treetop, a method called 'still hunting'. Buzzards have perfected this technique and will perch in wait, silently anticipating the slightest movement of a small mammal below.

It's not only movement raptors can spot though. Thanks to their ability to see ultraviolet light, these birds can also track their next meal via the UV components in the urine of their prey.

All this requires clean and healthy eyes, and in order to maintain a sharp, moist set of binoculars these birds have a nictitating membrane that wipes their eyeballs, similar to the wipers on a car.

**PILOTS OF PRECISION**

The wings of a raptor act as their natural engine, driving them through the skies and allowing them to navigate wind currents. The feathers that make up their wings consist of a fibrous protein called keratin, the same material found in human hair and nails. Layered like feathery scales, they vary in size and shape, carrying out different roles to ensure a smooth flight. Larger primary and secondary flight feathers at the

**Rarest of them all**

Birds of prey have been the focus of human persecution for many years. From the historic fall of red kites in the UK to the current downfall of the forest owl in central India, the decline of raptors is a widespread problem. The biggest threats raptors face is habitat loss and fragmentation, a threat that currently puts the existence of the rarest raptor of them all, the Philippine eagle, at risk. It is estimated that only 250 pairs survive in the wild today as a direct result of logging and loss of forest habitat.



Found only in the Philippines, these eagles face the possibility of extinction

ends of the wings propel the bird through the air and keep it airborne. The tail feathers, however, act as both a brake and steering rudder for a raptor, in a similar way to the rudder of a boat. Even so, different behaviours in raptors demand different shapes and sizes of wing.

Ospreys spend a great deal of time soaring over the seas and so have long, rounded wings, whereas hawks, which are more agile and rapid flyers, have shorter, narrower wings. Yet despite their impressive engineering, neither of these



Raptors typically have three toes pointing forward and one pointing backwards

birds (nor any other for that matter) can rival the kings of speed: the falcons. These incredible hunters are some of the fastest animals on the planet, and top of the pile is the peregrine falcon, which can nosedive at a speed of over 321.9 kilometres per hour. This speed and agility allows falcons to hunt other birds while still in mid-air. Diving to strike a pigeon, a peregrine falcon grabs onto its flying food in a manoeuvre described as 'binding to it' before bringing it back to its lofty nest to feast upon.

**BIRDS WITH BITE**

At the beginning of their lives raptors are born with an 'egg tooth' at the top of their beaks with which to break through their egg. As chicks grow they develop a characteristic hooked raptor beak

that they will soon begin to use to tear flesh, its sharp edges cutting away each bite. Though all raptors are fierce hunters they each have different palate preferences. Some enjoy the meat of mammals while others prefer fish, and like their talons, their beaks are adapted to suit their prey. There are even those that enjoy eating the entire animal, bones and all.

The bearded vulture has a diet consisting of around 80 per cent bone, and their beaks have to be particularly strong to break them apart. This might not seem like a nutritious diet, but the nutrients lie in the rich marrow within the bones of the animals they scavenge upon. Though their beaks are tough enough for the job, these birds also employ another method for bone breaking: they gather up bones then drop them while in

**How does a feather grow?**

Building a bird's greatest assets is a delicate process

**Bumpy start**

Small, raised bumps on the surface of a chick's skin known as placodes begin to form. These placodes then elongate to form a tubular structure known as the feather germ.

**Protection**

As a follicle develops keratinocytes produce keratin, which forms the sheath of the feather.

**Life blood**

Each feather has a blood supply until the feather is fully formed, hence why newborn chicks have blue quills.

**Sheathed**

Within the sheath a feather is developing from components called barbs.

**New plumes**

The protective sheath splits as the new feather emerges from the skin.

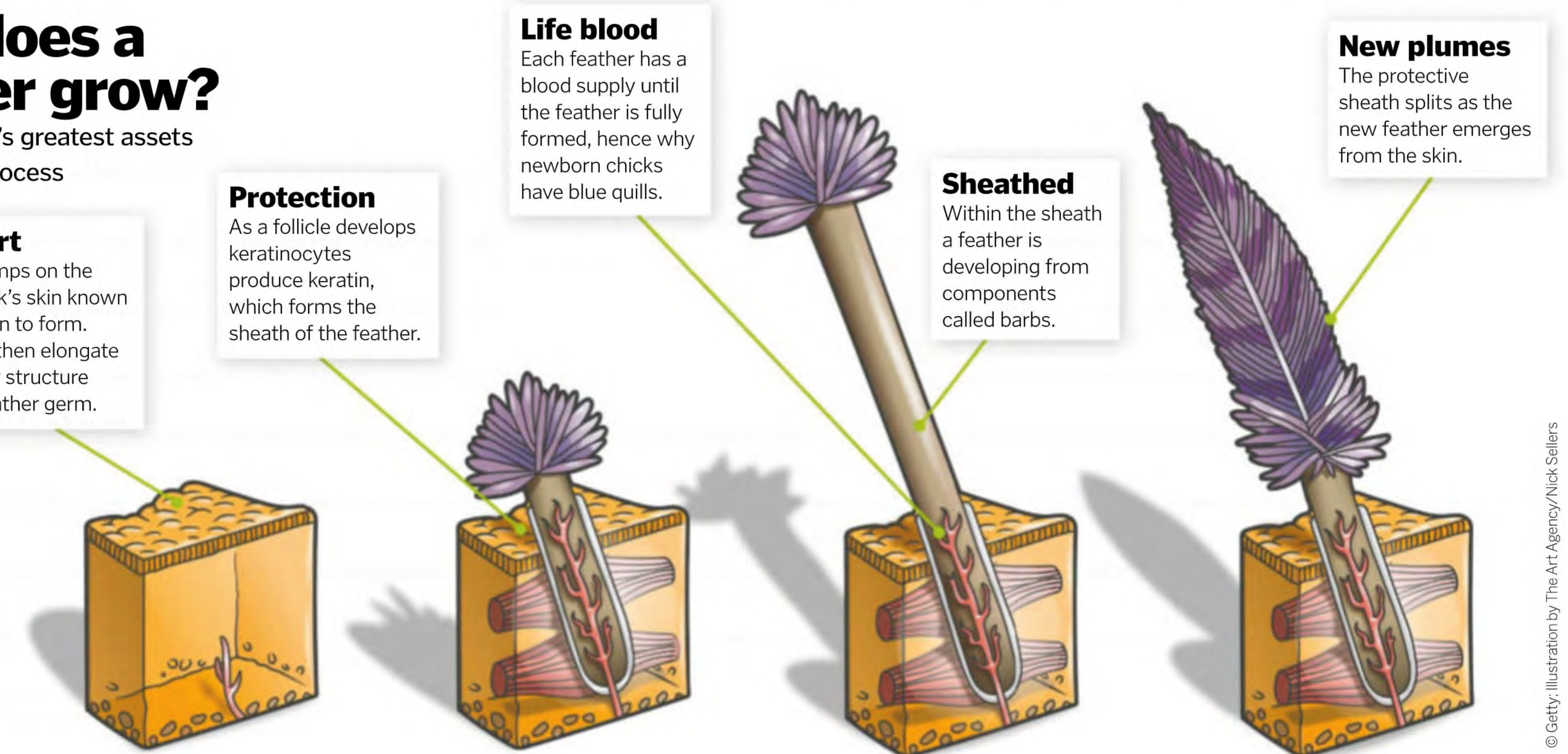

**DID YOU KNOW?** In Latin 'raptor' means 'plunderer' or 'abductor'

flight to break them apart. Once fragmented the bones are easy to peck apart, the vultures swallowing bits of the bone whole before their highly acidic stomach acid completely breaks them down.

**RULING THE ROOST**

Raptors are among some of the largest flying birds on our planet and need equally sizeable nests to raise their young. Known as an eyrie, these imposing wooden constructions are built high up in treetops, cliff tops and even on telephone poles. As a monogamous pairing, ospreys rear their yearly clutches together in the same nest for some 20 years. These creations can span between 1.2 and 1.5 metres, so as the years pass more and more material is added to the nest, sometimes extending its reach to some two metres in length.

Smaller species of raptor tend to incubate their young for around 28 days, whereas larger birds such as the golden eagle will sit on their eggs for around 45 days. Similar to gestation, the time until a chick fledges the nest varies depending on their size. Small raptors can leave the nest in around 28 days, whereas larger birds can take up to two and a half months.

Peregrine falcons have evolved air sacs that keep them oxygenated at speed


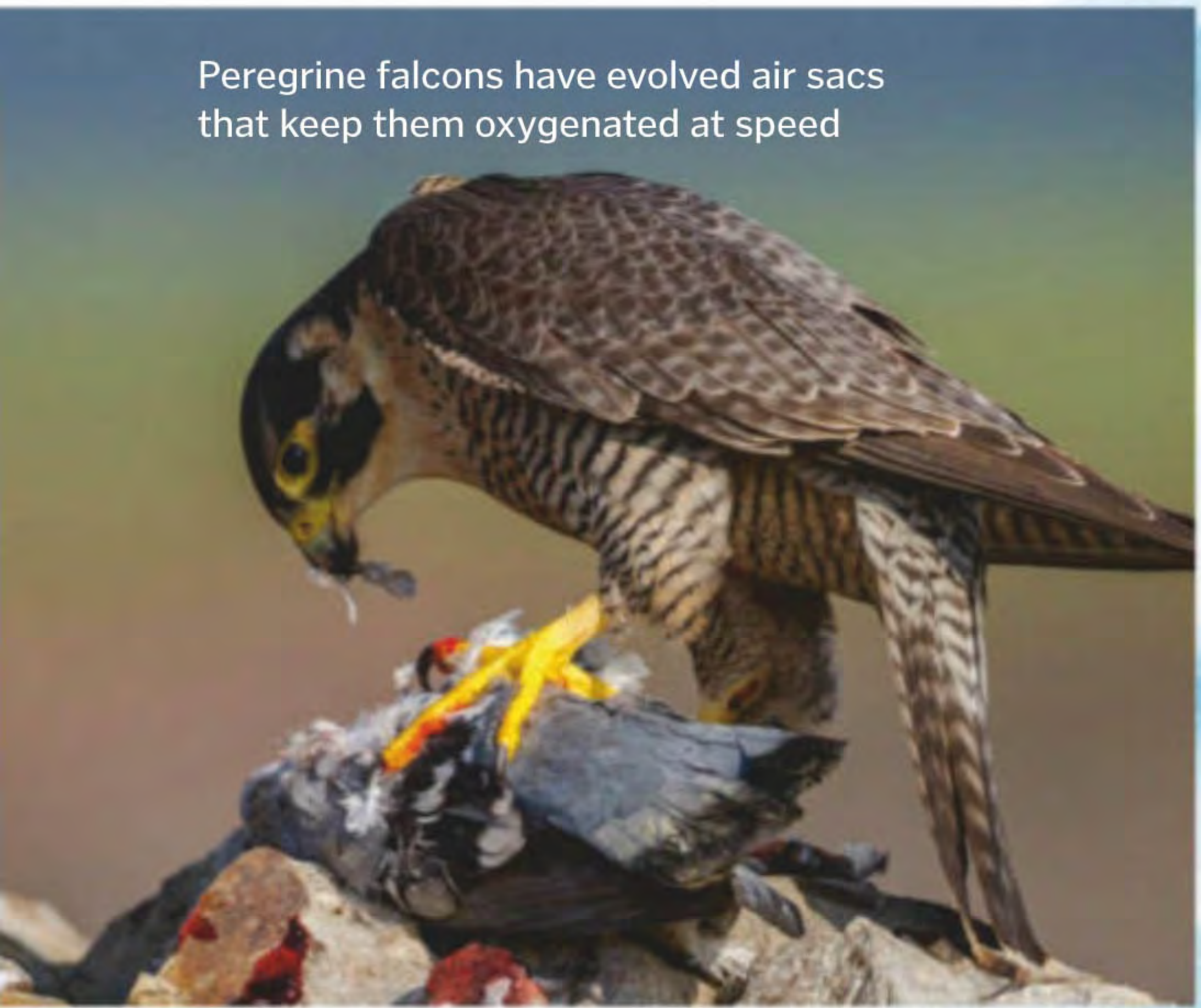

**Neck**  
Owls can rotate their heads up to 270°, and they have 14 vertebrae in their neck which helps them to achieve a wide range of movement.

**Lungs**  
An owl's lungs do not expand and contract like a mammal's would. Gas exchange occurs instead in the owl's air capillaries.

**Anatomy of an owl**

One of the world's most deadly predators is perfectly adapted for nocturnal hunting

**Gizzard**  
Here, inedible parts of prey (such as bones and fur) are held while this muscular organ breaks down the rest of the meal. These are then compressed into pellets and regurgitated later.

**Ears**  
An owl's ears are able to detect the slightest movements of its prey.

**Feathered feet**  
Unlike most raptors, the feathers of many owls reach all the way down to their toes. These feathers can be beneficial during hunting.

**Proventriculus**  
This is where the digestive enzymes are secreted to break down food in the first stage of digestion.



Bearded vultures are the largest birds in the Alps and number between 2,000 and 10,000 globally

**Incredible wingspans**

These raptors dominate the skies in which they hunt

-  **Andean condor**  
Wingspan up to 3.2m
-  **California condor**  
Wingspan up to 3.0m
-  **White-backed vulture**  
Wingspan up to 2.18m
-  **Bateleur eagle**  
Wingspan up to 1.9m
-  **Bonelli's eagle**  
Wingspan up to 1.8m
-  **Marsh harrier**  
Wingspan up to 1.3m
-  **Swallow-tailed kite**  
Wingspan up to 1.36m
-  **Buzzard**  
Wingspan up to 1.28m
-  **Peregrine falcon**  
Wingspan up to 1.15m
-  **Sparrow hawk**  
Wingspan up to 0.7m

*"The wings of a raptor act as their engine, driving them through the skies and helping them navigate"*

# Wildlife of Canada's boreal peatlands

Canada's northern wetlands are more than just a breeding ground for mosquitos – they provide resources for some of the planet's most impressive animals

Occupying a vast swathe of Canada's northern wilderness, the boreal zone is often described as a forest. Large parts of this region, however, are covered not by trees but by swamps, fens and bogs. Thanks to the high water table, many of these wetlands are underlain by peat, partially decomposed plant material that is great for the garden but provides poor growing conditions for trees. Boreal peatlands, or 'muskeg' as they are called in Canada, are instead dominated by mosses, lichens, low-growing shrubs and emergent aquatic plants such as sedges and cattails. Despite the cold winters, these features support a surprising variety of wildlife species, including some of Canada's most iconic fauna.

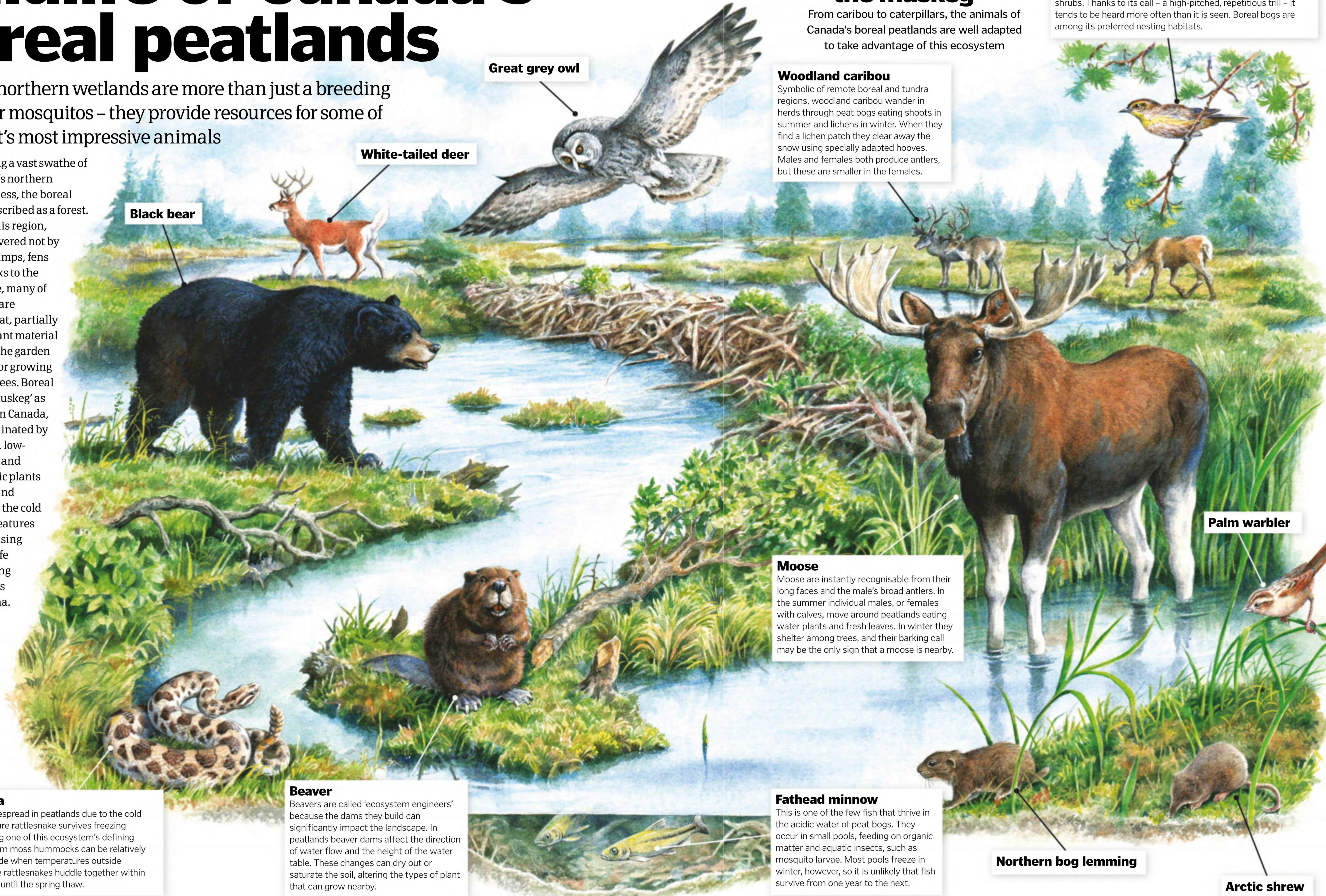

**Massasauga**  
Snakes aren't widespread in peatlands due to the cold winters, but this rare rattlesnake survives freezing conditions by using one of this ecosystem's defining features. Sphagnum moss hummocks can be relatively warm and dry inside when temperatures outside plummet, so these rattlesnakes huddle together within them to hibernate until the spring thaw.

**Beaver**  
Beavers are called 'ecosystem engineers' because the dams they build can significantly impact the landscape. In peatlands beaver dams affect the direction of water flow and the height of the water table. These changes can dry out or saturate the soil, altering the types of plant that can grow nearby.



**Fathead minnow**  
This is one of the few fish that thrive in the acidic water of peat bogs. They occur in small pools, feeding on organic matter and aquatic insects, such as mosquito larvae. Most pools freeze in winter, however, so it is unlikely that fish survive from one year to the next.

**Moose**  
Moose are instantly recognisable from their long faces and the male's broad antlers. In the summer individual males, or females with calves, move around peatlands eating water plants and fresh leaves. In winter they shelter among trees, and their barking call may be the only sign that a moose is nearby.

**Woodland caribou**  
Symbolic of remote boreal and tundra regions, woodland caribou wander in herds through peat bogs eating shoots in summer and lichens in winter. When they find a lichen patch they clear away the snow using specially adapted hooves. Males and females both produce antlers, but these are smaller in the females.

**At home in the muskeg**  
From caribou to caterpillars, the animals of Canada's boreal peatlands are well adapted to take advantage of this ecosystem

**Swamp sparrow**  
Unlike the common house sparrow, the swamp sparrow is hard to spot as it hides among the leaves of reeds, sedges and shrubs. Thanks to its call – a high-pitched, repetitious trill – it tends to be heard more often than it is seen. Boreal bogs are among its preferred nesting habitats.



**Palm warbler**

**Northern bog lemming**

**Arctic shrew**

## Land of moss



**Sphagnum peat moss**  
Different species of sphagnum grow in mats, hummocks or hollows. As it grows sphagnum releases acidifying hydrogen ions. Senescent stems, meanwhile, take decades to break down, causing an accumulation of partly decomposed material that feels spongy underfoot.



**Carnivorous plants**  
Peatlands offer poor growing conditions for plants, therefore some get their nutrients from sources other than the soil. Invertebrates are the alternative 'food' supply for pitcher plants, which digest those that fall into their cup-shaped traps, and sundews that snare unsuspecting bugs with their sticky leaves.



**Dung mosses**  
With so little exposed soil in peatlands, plants need to find other things to grow on. Splachnum mosses colonise moose droppings. Their spores are spread from one dung pile to another by flies. Different mosses grow on the dung of other animals, such as coyotes.

# EVERYTHING YOU NEED TO KNOW ABOUT THESE FEARSOME PREHISTORIC BEASTS

Find out how the dinosaurs survived and thrived, about the mass extinction event that ended it all, and what these ancient creatures left behind for us to find.



**ON SALE NOW**

**DID YOU KNOW?** The tallest tsunami wave ever recorded reached a run-up height of 520 metres!

## Rapid river waves

What exactly are tidal bores and how do they form?

**T**idal bores occur when previously calm river water is suddenly impacted by fast-travelling waves some few metres high. Flowing from the opposite direction as the river current, water from the river's mouth is sent back as waves known as bores.

There are thousands of rivers that deposit millions of tons of water into the world's oceans, but not every one experiences the ocean throwing water back into them in the form of a bore. That's because there are several conditions a river must meet in order for a tidal bore to form. The mouth of the river that empties into the ocean must be wide enough to filter the water

into the narrower inland part of the river, and the bed of the river must be relatively shallow.

Each year the Severn River in the UK has around 250 bores that travel atop its water. The most frequent and almost daily bore occurs in the Batang River in Malaysia and has been named Benak. These ocean tides aren't sending salt water upstream though; rather the ripple effect of their tides pushes river water at the mouth backward along the river. A full understanding of these impromptu waves is yet to be achieved, but like any tide, the gravitational pull and phases of the Moon play a vital role in their formation.

### Wall of water

Upward of 100,000 people gather each year to witness the 'Silver Dragon', a tidal bore that can reach up to nine metres high to create a wall of water that cascades down the Qiantang River in China. The Qiantang bore is the world's tallest bore recorded to date, with its ferocious waves travelling 40 kilometres per hour down the 494-kilometre-long river. As a result of this bore's sheer power, 42.5 billion cubic metres of sand has been deposited in the river.

Records of the bore's occurrence in the river date back almost 3,000 years, and the colossal waves occur during every eighth month of the Chinese calendar, a regularity that has encouraged a viewing festival to be held on the 18th day of that month so that people can witness the watery wonder.



Thousands gather along the Qiantang River bank to witness the world's largest tidal bore

### Making waves

What is needed to form these giant ripples?

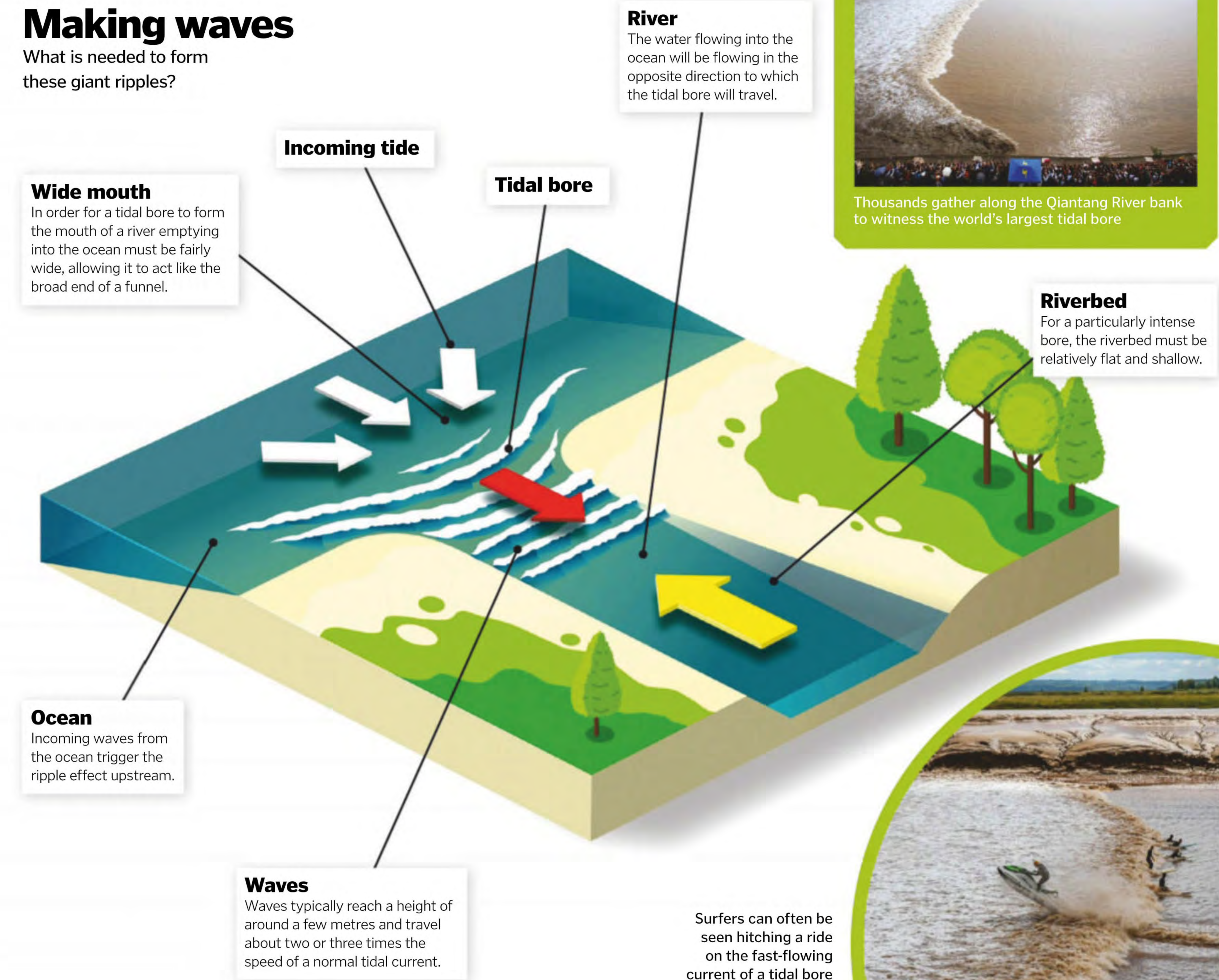

© Alamy. Illustration by The Art Agency/Nick Sellers

Ordering is easy. Go online at:  
**www.myfavouritemagazines.co.uk**  
 Or get it from selected supermarkets & newsagents



# EARTH IN A YEAR

Compress Earth's unimaginably vast history into 12 months and humans saunter in just in time for the New Year's party

**4.54 BILLION YEARS AGO**  
 Earth is estimated to be about a third of the age of the universe. The Sun and planets formed from the cloud of dust and gas that comprised the young Solar System when gravity caused material to clump together.

**4.51 BILLION YEARS AGO**  
 The Moon was formed not long after the Earth. According to the most widely accepted theory it was created when Earth collided with another planet in a 'giant impact', sending debris into orbit.

**1.2 BILLION YEARS AGO**  
 At some point around a billion years ago a few organisms stopped reproducing by simply splitting in half and started to reproduce sexually with other members of their species.

Some scientists believe that high-speed crashes in space created celestial bodies like the Moon



**3.5 BILLION YEARS AGO**  
 Around 3.5 billion years ago, after asteroids had stopped raining down on the planet, Earth became less barren as life evolved. These organisms, each made up of a single cell, are the ancient ancestors of every species alive today.

**2.4 BILLION YEARS AGO**  
 Certain bacteria began to use sunlight to convert carbon dioxide and water into sugar - the same process used by green plants. Oxygen was released as a waste product, creating an oxygen-rich atmosphere that would later support animals with lungs.

Insects were flying around long before dinosaurs came onto the scene



**175 MILLION YEARS AGO**  
 The supercontinent Pangaea began to split apart. Carried in different directions by tectonic activity, the pieces would eventually become the modern continents.

**200 MILLION YEARS AGO**  
 Early mammals evolved - these were small, nocturnal shrew-like animals that hunted insects. Mammals stayed in the background until the extinction of the dinosaurs, after which they rapidly diversified and grew.

**240 MILLION YEARS AGO**  
 Dinosaurs evolved from other reptiles and began to roam the Earth. When the planet's history is compressed into a year, they survived for just two weeks.

**400 MILLION YEARS AGO**  
 Insects appeared at least 400 million years ago - possibly as early as 480 million years ago. Early species were restricted to crawling over land and plants, but one line went on to evolve wings and take to the air.

**470 MILLION YEARS AGO**  
 The first plants to emerge on land resembled mosses and liverworts. They lacked roots and transport systems, relying on fungi to provide them with water and nutrients in exchange for some of the organic compounds they produced during photosynthesis.

**AROUND 315,000 YEARS AGO**  
*Homo sapiens* - modern humans - evolved from another human-like ape. They lived alongside Neanderthals for thousands of years but eventually became the only remaining *Homo* species.

**130 MILLION YEARS AGO**  
 Plants first burst into bloom at least 130 million years ago. It could have been earlier, but because they were so delicate few ancient flowers were fossilised.

**1492** Christopher Columbus 'discovered' the Americas. He landed on an island in the Bahamas after a two-month sea voyage from Spain.

**1066** Following the death of Edward the Confessor, William the Conqueror defeated Anglo-Saxon king Harold Godwinson at the Battle of Hastings and claimed the throne as the first Norman king of England.

**2560 BCE**  
 Ancient Egyptians picked up their tools and started building the pyramids. These impressive structures served as tombs for pharaohs and their families.

**1760** A surge in technological innovations kick-started the Industrial Revolution. This was a period of unprecedented growth in industry, manufacturing, economy and population.

**1666** The Great Fire of London began in the middle of the night in a small bakery. It raged through the city for nearly five days, ultimately destroying over 13,000 houses.

**68 MILLION YEARS AGO**  
*Tyrannosaurus rex* first appeared, measuring over 12 metres from head to tail. In this geologic year, the most famous of all the dinosaurs would only have six hours to stomp around and terrorise smaller creatures.

Relatively speaking, the pyramids of Egypt aren't ancient at all



**DID YOU KNOW?** The túngara frog's Spanish name (*sapito de pustulas*) means 'pustulated frog'

**Spacious home**  
The thrashing limbs of several enthusiastic frogs allow a mother to build a foam nest many times bigger than herself.

**Complex building materials**  
Proteins within the female's secretion have antimicrobial properties and act as surfactants to stabilise the foam.

**Air supply**  
The bubbly foam contains all the oxygen the developing tadpoles need while they're in the nest.

**In-built meals**  
Developing within the nest, embryos rely on the nutrients in their eggs to help them survive and grow.

**Big family**  
The foam nest needs to be roomy, because a female frog can lay thousands of eggs each breeding season.

**Safe shelter**  
Under the hard outer layer the embryos are protected from microbes, predators and the harsh sunlight.



Grey foam-nest tree frogs spend more time in the trees than in the water



**Grey foam-nest tree frog**  
*Chiromantis xerampelina*  
**Class** Amphibia  
**Territory** Central, Eastern and Southern Africa  
**Diet** Insects  
**Lifespan** Unknown  
**Adult weight** Unknown



"The process can take hours, so the female will have breaks to rehydrate"

# The foam-nest frog

Many legs make light work of these frothy egg holders

**C**hiromantis is a genus of frog found in Southeast Asia and the sub-Saharan tropics of Africa. These frogs are known as the foam-nest tree frogs because of the impressive frothy structures they create when rain signals the start of the breeding season.

While the foam nests may appear simple in comparison to other feats of animal architecture, they have some peculiar properties, and, in the case of the grey foam-nest

tree frog, are the work of many determined legs. Their nests are created when a female attracts multiple males, who will compete for access to her. The successful individual will then climb onto her back before she secretes a fluid that she will beat into a foam along with her mate, both frogs using their back legs to whip it up.

When a large nest of bubbles has formed the female begins to lay her eggs, which the male then fertilises. The process of frothing and egg

laying can take hours, so the female will have breaks to rehydrate. Other males will by now have arrived to contribute to the fertilisation process. When all her eggs are laid and fertilised the frogs part ways and the foam is left to develop a protective crust.

After four to six days the tadpoles are ready to hatch. The bottom of the nest becomes soft, so the tadpoles are able to wiggle out of their eggs and drop straight into the water below.

## Other bubble builders



**Fighting fish**  
Males build bubble nests then wait for females to take notice. Eggs are placed among the bubbles to keep them aerated.



**Froghopper**  
Nymphs of this insect family cover themselves in foam made from plant sap. The frothy case hides and hydrates them.



**Túngara frog**  
Female túngaras choose males with attractive calls before the pair whip up floating nests on marshes or ponds.

**Waterfront property**  
The nest is carefully positioned over water so the tadpoles can drop safely when they hatch.



### About Westworld

The hit HBO series *Westworld* takes place in the not-so-distant future, where citizens can visit a theme park built around the aesthetic of the old American western frontier. The park is home to thousands of 'hosts' whose sole purpose is to create the most immersive experience for their guests. But these hosts aren't actors - they're machines. **How It Works** investigates how close we are to stepping into the future so that we can jump back into the past.



## COULD WE BUILD A REAL-LIFE...

# WESTWORLD?

Terraforming, quantum computers and synthetic life - welcome to the theme park of tomorrow

Words by James Horton

Imagine that you step off a train and into the outskirts of a dusty town. The streets are filled with life: the vendors are bartering, the sheriff's deputies are patrolling, the drunks are gambling. With a six-shooter strapped to your side and a Stetson hat keeping the Sun from your eyes, you swerve past a set of Wanted posters and through two swinging doors. Inside the saloon an old bandit catches your eye and makes you an offer. There's a wagon of treasure under guard just out of town, and if you help him take it by force you'll get half the loot. Even though you're stood in an amusement park that's modelled on the Old American West, you're surprised to see that the bandit believes every word they've just told you - because for them it's reality. This is the only story, the only world, the bandit has ever known, and there, in that moment, you get to play your part in it. Welcome to Westworld.

When the first episode of *Westworld* aired in October 2016 it revealed an exciting world of wonder, but one tantalisingly out of reach. Many of the technologies in the programme were familiar to us and have already been the subject of much study. Artificial intelligence, bioengineering and robotics form the centre of this science-fiction universe and have been at the forefront of academic research for decades. Today's scientists harbour many dreams for their work, but *Westworld* is centred around the ultimate culmination of these technologies - the

creation of synthetic sentient life. The show challenges us to ask whether we could create consciousness and what the consequences could be if we were to do so. The sceptic reader may scoff at this notion, but we may be closer to achieving this than you might think.

The aforementioned bandit, like all of the other hosts inhabiting *Westworld*, would be these synthetic creations, constructed from and designed to mimic humans so closely that they are all but human, only they are hybrids of our organic cells and the inorganic computers we've created. For the vision of *Westworld* to be realised so to would the goal of building sentient

*"We may be closer to creating consciousness than you might think"*

life, and we shift closer to realising this ambition each day. Science and technology news is often dominated by reports of reaching new milestones in AI. Computers now dominate humans in a host of games, including chess (a game of logic), Go (a game of intuition) and Jeopardy (a game of wordplay and trivia). In the broader world

advanced algorithms known as neural networks (inspired by the human brain) have learned to read our voices and respond to our commands. They're also learning to drive vehicles, are integrated into the software on our phones and work behind the scenes on our favourite websites. We often talk of the impending age of AI, but in truth it's already here.

Alongside advances in algorithm design, Moore's Law is currently keeping pace. For over

### 3D-bioprinting

Since its conception in 1986, 3D-printing has been propelled to success by the coevolution of computer software design and machinery engineering. With the basic premise of assembling thin and accurately placed sheets of material layer by layer, 3D printers promised to build impressively complex three-dimensional shapes. This inspired many people to ponder on its applications; for engineers the use was apparent, but many in the field of medicine grew curious if they too could print structures. These scientists considered whether they could build structures from living cells.

With the help of X-ray, MRI and CT scans, some scientists have become invested in employing biomimicry - copying structures seen in nature - to build a human body. By arranging lab-grown human cells and encouraging their growth with supportive matrices and nutrients, we could eventually build working organs. The hosts of a real-world *Westworld*, then, would be largely human in terms of their cellular structure, but rather than growing organically from an embryo to adulthood they'd be assembled and emerge into the world fully formed.

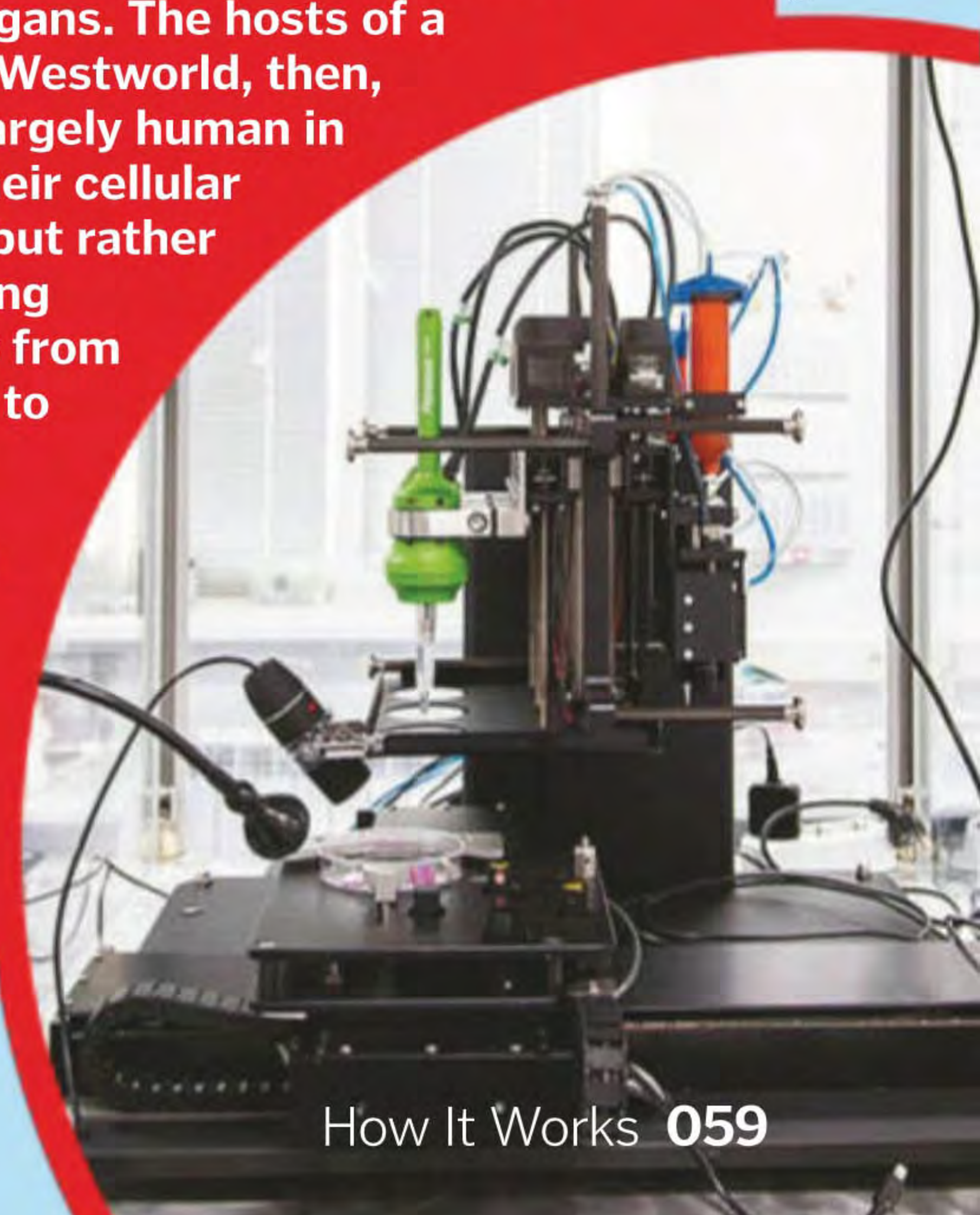

© Getty



five decades the observance that computers grow twice as powerful every two years has mostly held true, and we've been able to harness these ever-more-powerful computers to power our newest and greatest AI.

On the robotics side, institutions including Boston Dynamics and NASA have made amazing progress into the mechanics of synthetic humanoids. Whereas we humans rely on a complex, interwoven network of muscles for balance, strength and dexterity, a bi-pedal robot achieves these attributes using hundreds, if not thousands, of carefully placed actuators (tiny motors). But if the goal is to faithfully emulate the human form, the best way would be to use the same material – living tissue. Scientists have also been hard at work making progress here, and we can expect more to come as we advance our ability to manipulate human cells.

With artificial intelligence, computing power and a humanoid shell all in the works, are the hosts of *Westworld* just over the horizon? Alas, not quite. There is a brick wall ahead that we can all see, and we must tear it down before we can continue. Moore's Law will inevitably begin to crack, and without an exponential increase in computer power we've little hope of capturing human-level intelligence and sentience in a machine. This brick wall, however, is no immovable object, and we're developing the bulldozer for its destruction. The saviour technology's name? Quantum computing.

Moore's Law will fail because there's only so small a single transistor can go. For computers to become more powerful and efficient, the processing units must get smaller. At the tiniest of scales, fundamental particles such as electrons begin to act a little spooky. Bizarrely,

## Building a blood vessel

Using bioink-based technology to create a host's circulatory system in the lab

### Computer-aided design

Scans of human tissues will act as instructions for the computer software that will guide the printing process.

### Printer head

The bioink is deposited accurately and in small volumes using thermal energy or acoustic forces to forcibly eject ink from the nozzle.

### Fusion

The cells now mature and develop using the extracellular matrix's support, fusing into a cohesive structure.

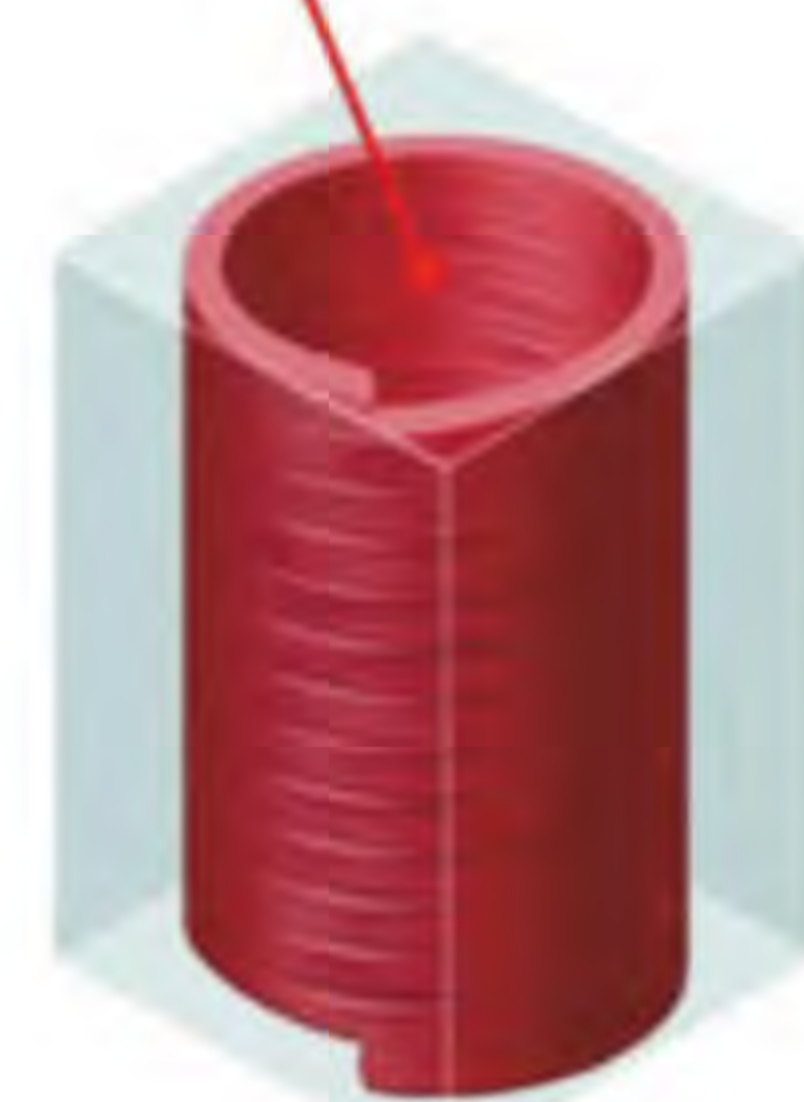

### Working tissue

The synthetically created blood vessel is complete and ready to be combined with other tissues using a similar fusion-based technique.



### Extracellular matrix

Cells are placed layer by layer atop an extracellular matrix, which acts as both a binding surface and structural support.

### Bioink

Living cells suspended in a liquid culture form a 'bioink'. The nutrients in the liquid medium will support cell growth after printing.

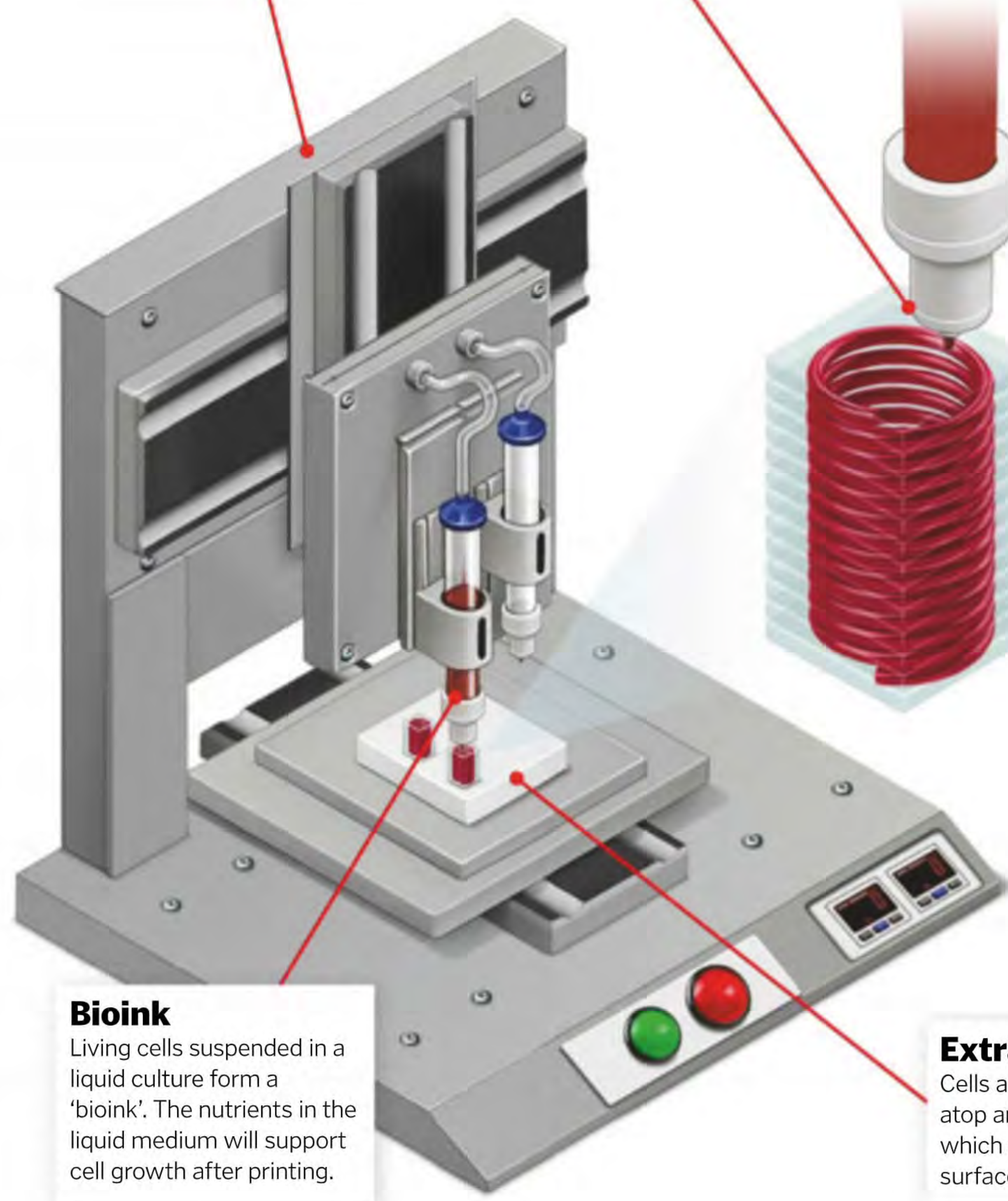

## Bioreactor-grown organs

In tandem with developing biomimicry-based bioprinting, biologists have been attempting to grow organs in the lab starting from their 'embryonic state'. One main goal of this research is to produce personalised organs that can be transplanted in place of the donated organs that are used today. Donated organs are often recognised as foreign by the recipient's immune system and attacked, meaning that the patient must rely on immunosuppressants to keep the organ in working order. Organs grown from the patient's own cells would bypass this issue, however. But as well as being a promising future treatment, this technology would serve ably as a method for creating biological hosts.

The ability to grow human organs in the lab relies on three primary criteria: stem cells, 'scaffolds' and bioreactors. Stem cells form the basis for all our cells. They begin life as unspecialised but later differentiate and specialise depending on their environment. The 'scaffold', which can be organic or synthetic, forms a matrix that the stem cells can bind to and receive cues from, informing them on which cells to specialise as. The final step is a bioreactor, which nurtures the growing cells until they reach maturity.

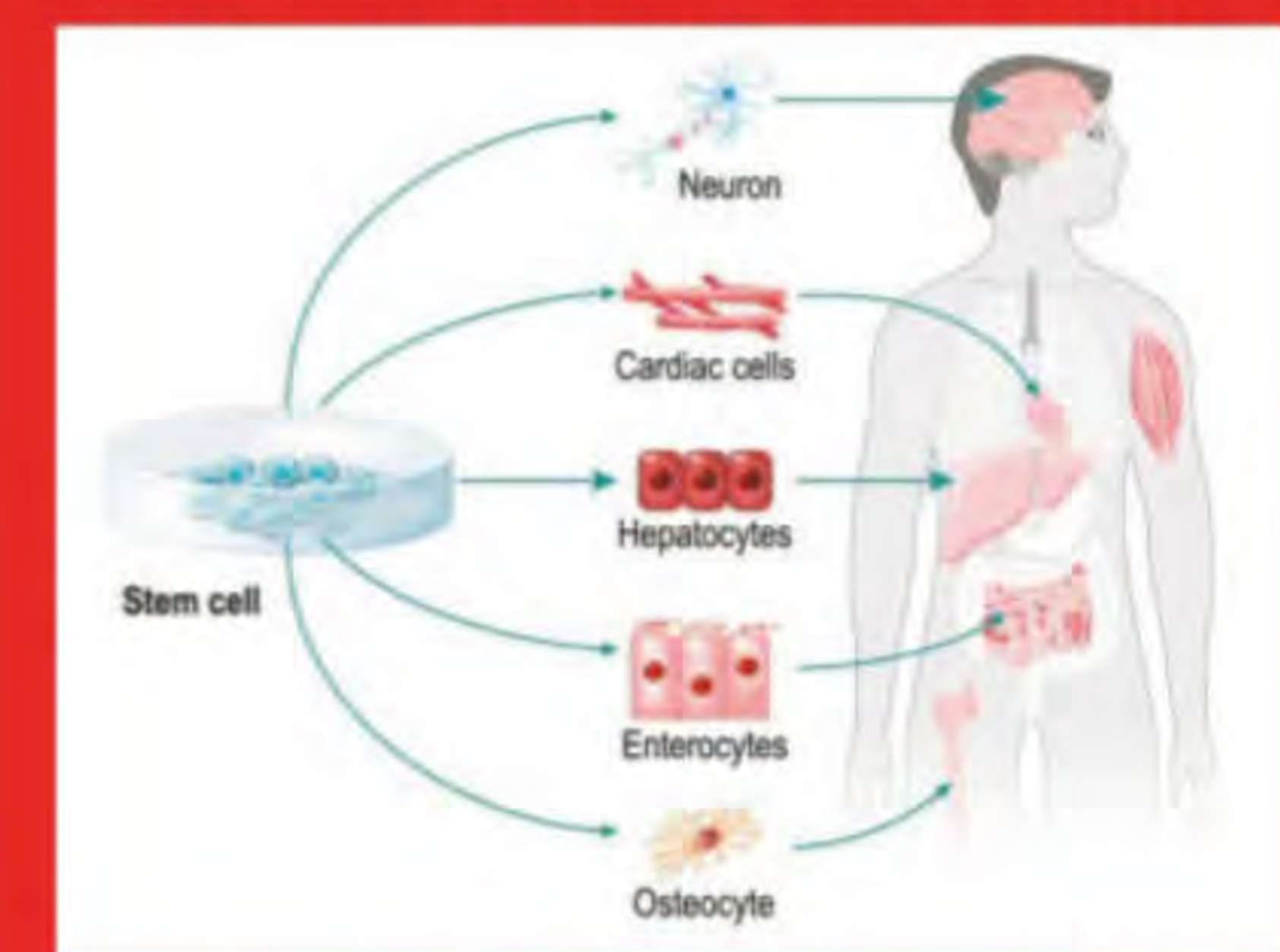

Pluripotent stem cells, the 'master cells' of our body, can specialise into any cell type

"I think the best bet for achieving conscious machines is via DNA-based systems"

**DID YOU KNOW?** In 2016, Harvard scientists used bioprinting to create a 'heart-on-a-chip', which behaves like living tissue

we can't be entirely sure where they are when we're looking in a tiny space. Imagine a computer as funnelling a chain of electrons down a series of tunnels separated by thin walls. Quantum theory tells us if a tunnel were to become too narrow the electrons may well 'jump' to the other side of the wall. This aspect of the universe means we're limited in how far traditional computing can take us, but quantum computers aim to turn these funky features into assets for superfast computing speeds.

As well as a particle being uncertain where it is in space at small scales, it's also uncertain as to what it is. Particles can orient themselves in a variety of 'states', but before they've committed to one they can be in a state of 'superposition', meaning they're in every state at once. If you think this is weird then you're not alone – many physicists feel the same way! But we can utilise this quirk in computing. A traditional computer bit switches between a 1 and 0 when processing, but a quantum-bit, or qubit, can be both at the same time, unlocking exponentially increased processing power for every new qubit you add.

The processing power granted by quantum computing may not be the only reason it's an essential ingredient. Superposition, as it turns out, may also be what underlies human consciousness. This may sound complicated, but it essentially boils down to many versions of our synapses (the chemical communications in our brain leading to our decisions) all

occurring at once. The reality we live in is the one that encompasses our consciousness. This is a little mind-boggling, but suffice it to say that if we need quantum effects for human-level consciousness, then a computer may need it too.

Fortunately, by the time we've cracked synthetic life the other elements that make *Westworld* such an immersive experience will surely have been mastered. When you're strolling around as a revolver-wielding gunslinger and you're faced with a group of similarly equipped hosts who'd rather you were dead, for example, you need to know the park's owners will keep you safe. In the show, a host cannot cause severe physical harm to a guest,

and their bullets, although capable of killing other hosts, will only bruise a human. Alternative Ballistics has already created an 'air-bag' for a bullet that slows it to 20 per cent of its speed. The park's creators could incorporate an optional internal membrane that achieves a similar effect. Coupled with host-recognition technology, a gunshot will be slowed unless the projectile is pointed at a host.

Ultimately, the main sticking point to realising the world's most daring theme park is creating its inhabitants. But we can be certain that when they finally get here, everything else will be ready for them. Will you be ready to play? If so, pick up your black hat, and I'll see you there.



The EDRS will allow for up to 1.8 gigabits to be transferred each second

## The European Data Relay System

Swiftly transferring large amounts of data would be an essential feature for a real-life *Westworld* theme park. Hosts would be constantly relaying data to the central hub and receiving regular updates in return, plus, there may be a need for an immediate shut down if an uprising were imminent. Fortunately, a technology such as the ESA's SpaceDataHighway would allow for such ultra-speedy data relays using strategically positioned laser-equipped satellites.

The problem with transferring data via satellites positioned in low Earth orbit (about 180 to 2,000 kilometres above us) is that they zip around the planet very quickly and so are not able to directly communicate with relays on the ground very often. The EDRS, however, gets around this by placing an additional satellite in geostationary orbit (roughly 35,500 kilometres away). At this distance the satellite will orbit the Earth at the same rate as the planet rotates, so as a result the satellite remains in the same position relative to those on the ground.

Thanks to this addition data can be transferred from a low Earth-orbiting satellite to the geostationary satellite via lasers, which can then be transferred to the ground unit using radio waves. The result is an incredibly fast and high-throughput communication stream fit for a *Westworld*.

The hosts of *Westworld* are synthetic humans who believe their role in the theme park is real



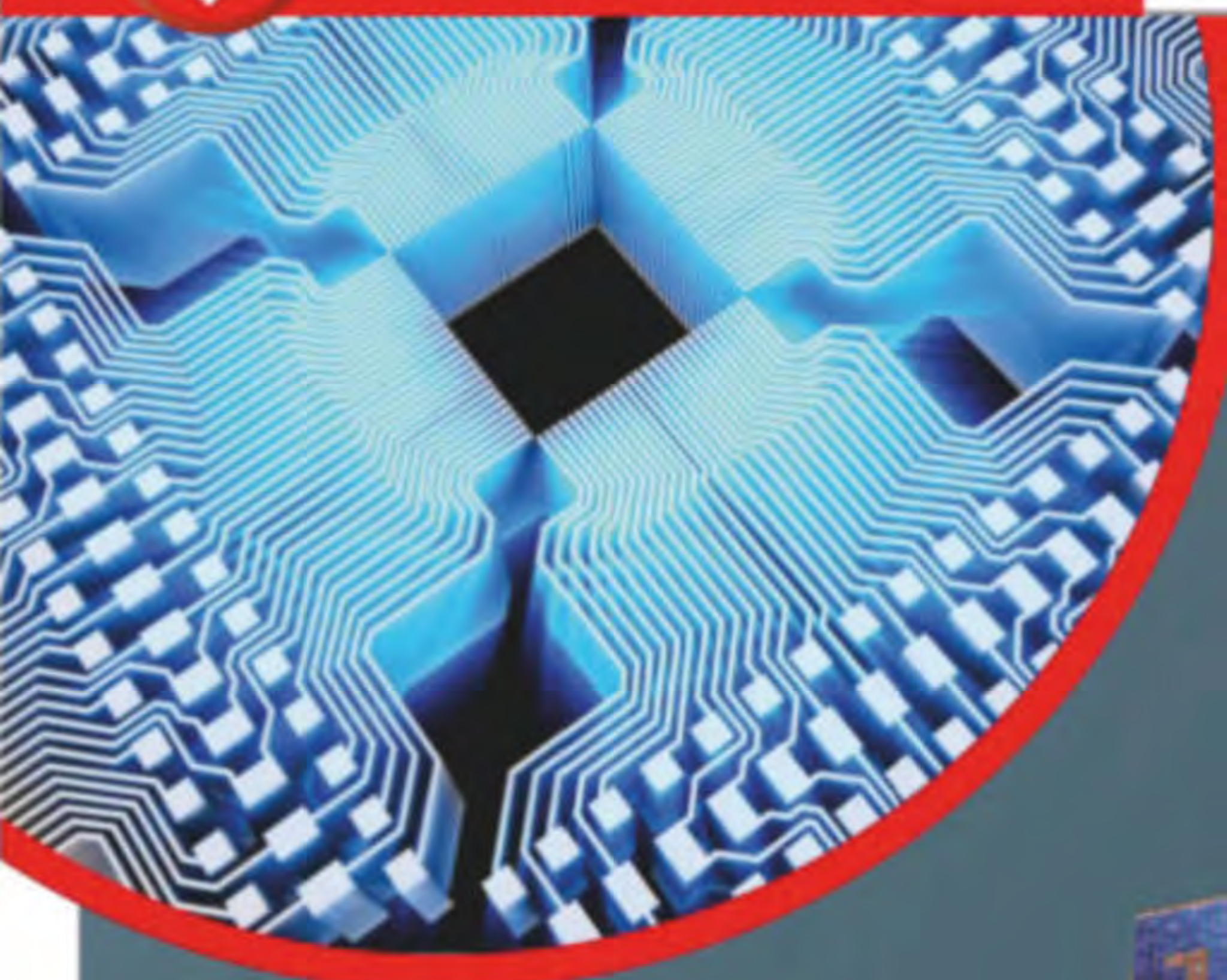

Developing quantum computers may be essential before we're able to create synthetic life

### Creating the park

How we could use terraforming to construct an artificial world

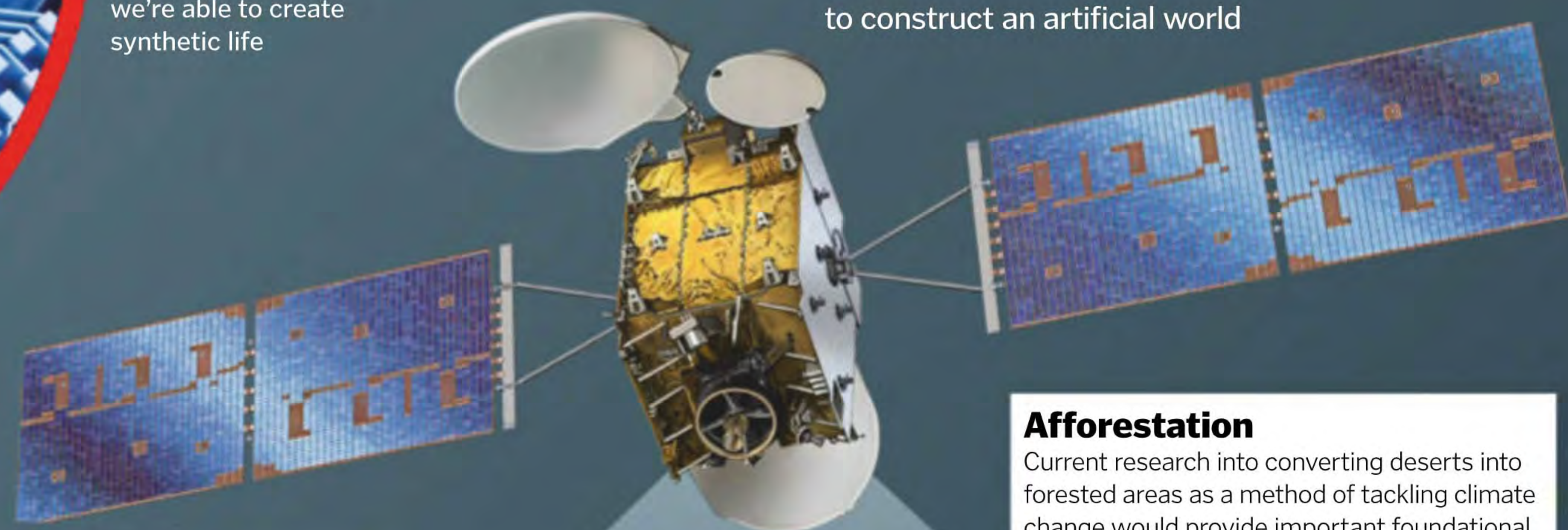

#### Territory

Humans now cover a considerable amount of the Earth's land surface, but arid, mostly lifeless swathes of desert remain unoccupied.

#### Flora

Planting river red gum, Joshua and palo verde trees that grow well in desert heat will help establish a biosphere for other plant life to follow.

#### Afforestation

Current research into converting deserts into forested areas as a method of tackling climate change would provide important foundational knowledge for Westworld designers.

#### Underground network

Tunnel-boring machines would carve tunnels for staff to travel unnoticed and pipework to move fresh water throughout the park.

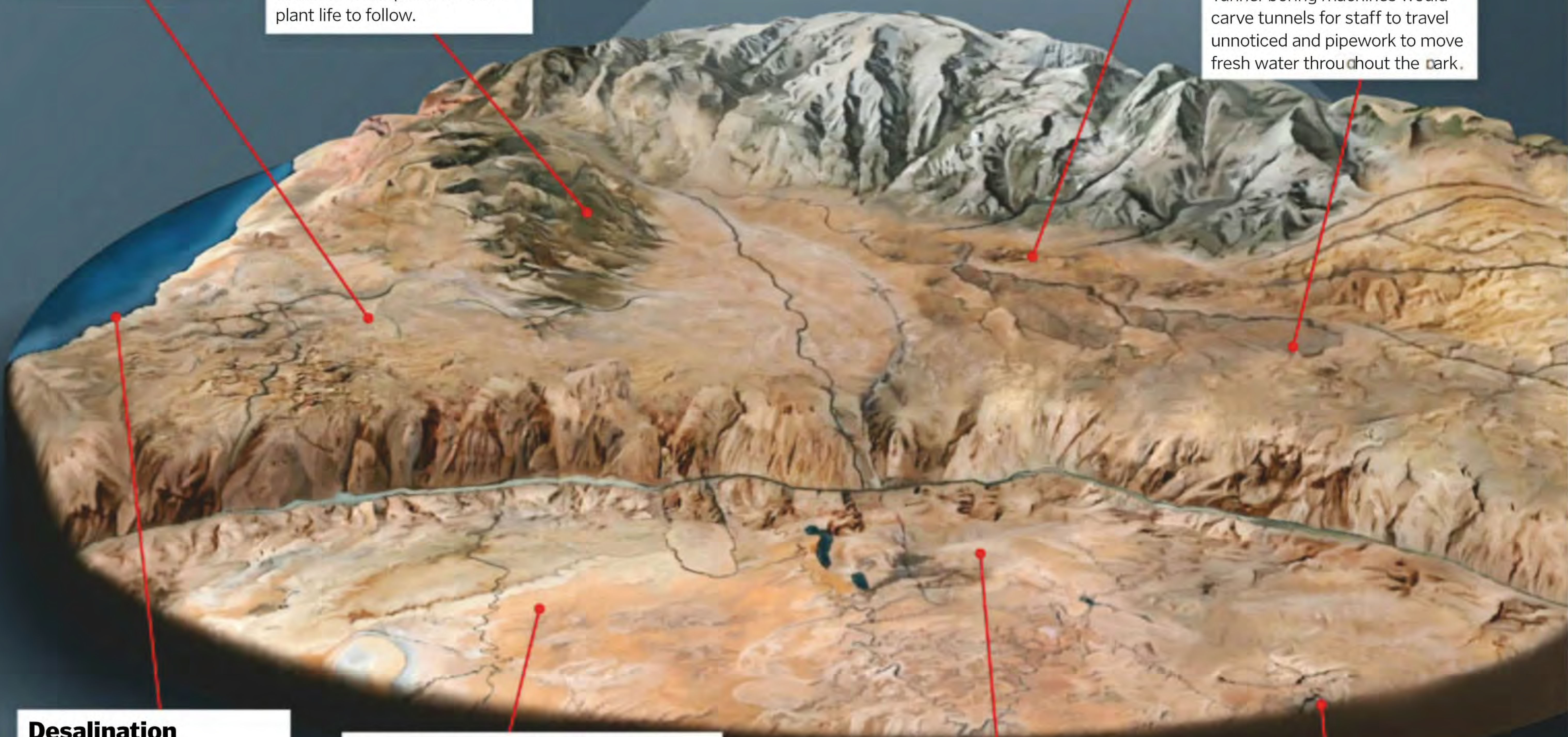

#### Desalination facilities

If the park's boundary meets a sea, then desalination plants could be used to convert salt water into drinkable fresh water.

#### Location, location, location

A desert area with California-esque temperatures would be optimal. A large pacific island, a segment of the Sahara Desert or the Australian outback could host the park.

#### Excavation

The park's terrain could be swiftly transformed with the help of mammoth excavators. Today's largest can move 9,000 tons in just one hour!

#### Scale

A full-scale park would need to stretch for over 40km end-to-end, occupying up to 1,300km<sup>2</sup>.

### Tracking guests

With hosts and guests sprawling all over a massive expanse of park, an accurate tracking system becomes a must-have for any Westworld designer. Of all the technologies needed for the park, however, this one is by far the easiest to obtain. We already have GPS trackers inbuilt into our mobile phones, which are accurate to about 4.9 metres. But to take it one step further the founders of Westworld would likely want to use a similar system to the US military. They use two GPS frequencies in place of one to reduce the location error caused by our atmosphere, meaning all who enter the park could be followed with pin-point accuracy.

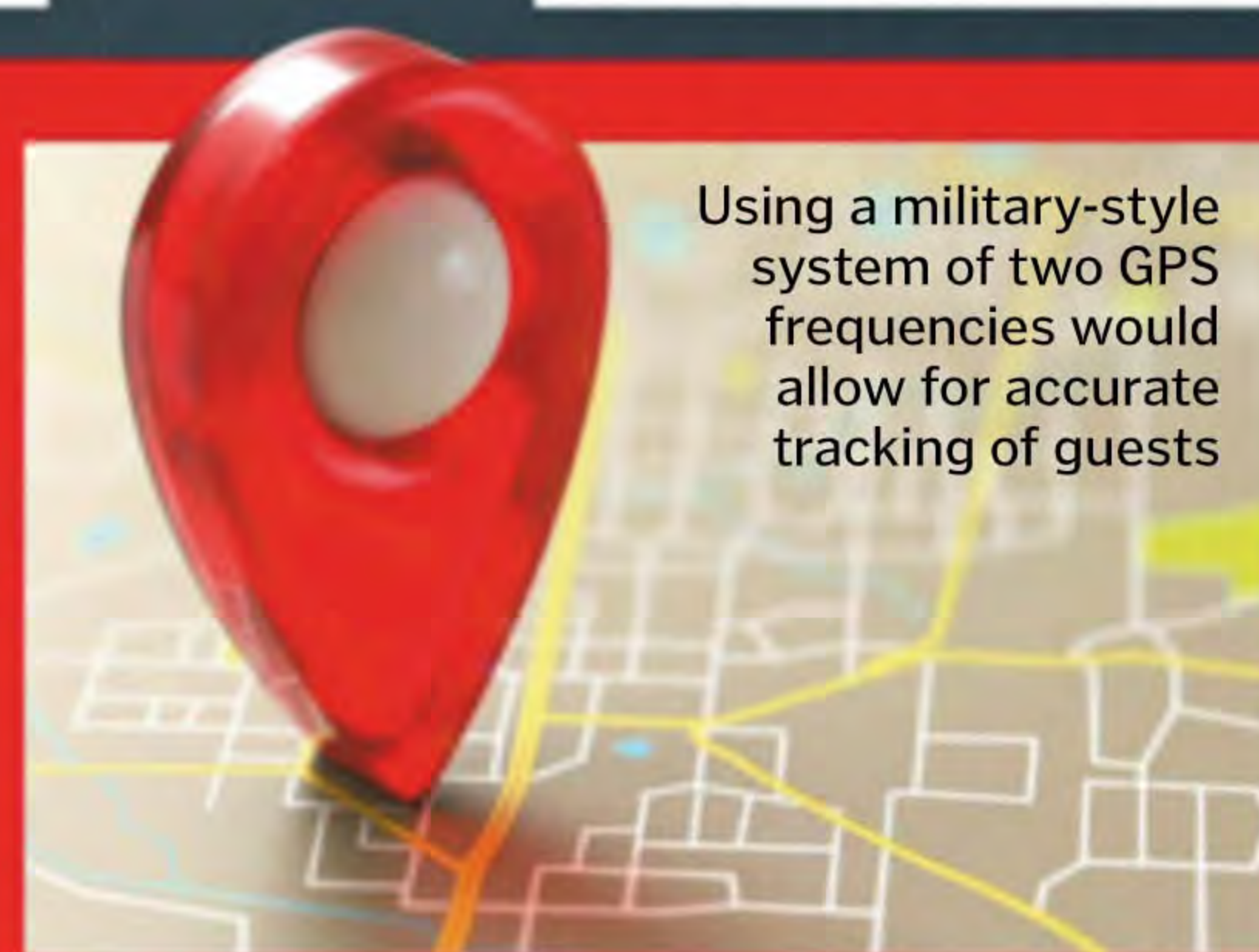

Using a military-style system of two GPS frequencies would allow for accurate tracking of guests

*"There may be a need for an immediate shut down if an uprising were imminent"*

### Mood-reading Pianolas

Player-pianos, otherwise known as Pianolas, play their music autonomously. As air floods through punctured holes in the Pianola's score the change in pressure forces the desired key to be struck. To an unsuspecting observer, it may look as if a ghost is operating the instrument, and in the park of Westworld this creates a haunting and intriguing atmosphere. But we need not stop there.

With the aid of mood-sensing algorithms capable of judging tonal quality – which have already been developed – the Pianola may sense our mood and adjust its playing accordingly. So when you're exploring inside Westworld you can rest assured that you'll always have a fitting soundtrack punctuating your journey.

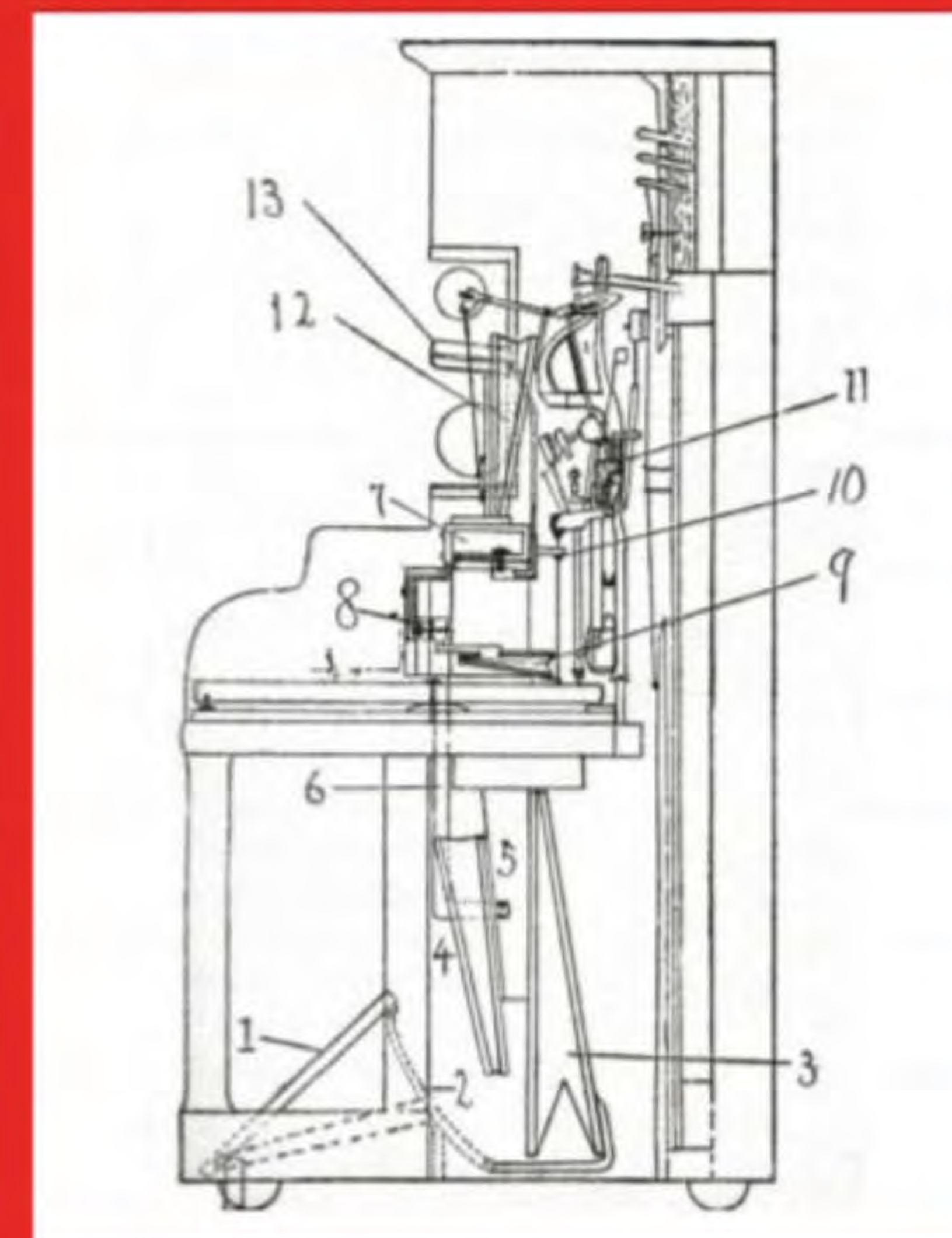

Pianolas rely on a series of valves and membranes to strike keys when triggered by an influx of air

## Q&A Can we create consciousness?

How It Works talks with Professor Subhash Kak on the challenges of creating synthetic sentience



**Subhash Kak**  
Regents Professor of Electrical and Computer Engineering

Professor Kak is based at Oklahoma State University, Stillwater, US. As well as being a renowned expert in quantum computing and neural networks, he has authored 20 books, including *The Circle of Memory* and *Mind and Self*.

the human brain in the level of complexity, it is also likely that some aspects of brain processing are quantum mechanical. But it doesn't follow that currently conceived quantum computers, which are designed to perform digital processing, are the right architecture for consciousness; indeed, it is almost certain they're the wrong architecture. To achieve conscious behaviour, alternative models of quantum computers that parallel the kind of modular and hierarchical processing that occurs in the brain will have to be explored, and even this might only be necessary and yet still insufficient."

**One barrier to an artificial intelligence achieving consciousness is Alan Turing's 'halting problem', which explains that no human-designed algorithm can halt its processing at a random point like the human brain is able to do. Although popular algorithms such as neural networks (used by Google's DeepMind and Amazon's Alexa, for example) are inspired by their biological counterparts, it may be that we are losing some crucial details as we simplify our organic pathways into computational ones. With this in mind, do you feel our current approaches to algorithms are complex enough to facilitate consciousness?**

"I don't think there is currently any serious attempt to create machines that are conscious the way humans are. Of course, there are projects where machines or robots can operate autonomously in environments with uncertainty, but the basis of their intelligence is pattern recognition, i.e. the machine is able to recognise the patterns it has been trained on and also their generalisations, and then given where it is, it chooses a response out of a menu of many responses. This is all current 'intelligent' machines do, and just increasing complexity will not facilitate the emergence of the new phenomenon of consciousness."

**Quantum computing promises to be a way for us to unlock much faster processing speeds, but some physicists have gone further and suggested that quantum effects (where particles can exist in many states at once) may also occur in the human brain and act as the basis for consciousness. If that is indeed the case, will consciousness become an inevitable outcome as a quantum computer becomes sophisticated enough?**

"The classical computer is not only inferior to

**It's hard for humans to determine if other species are truly self-aware because we can only appreciate consciousness from our own narrow perspective (take the intelligent octopus, for example). So if a computer is one day able to achieve a conscious-like state, do you feel humans will be able to recognise a form of sentience that's unlike our own?**

"If computers did achieve consciousness it will quite be like ours, and we humans will be able to establish a connection with them just as we do with other sentient animals. Still, just as each animal sees the world in a way unique to its species, conscious computers will be different from us. We cannot predict the nature of dissimilarity between their sentience and ours, but it is certain they will exceed us in reasoning capacity, memory and physical agility, and they may have no use for us."

**Finally, what to your mind is the immediate major hurdle – technological or otherwise – that humankind will first need to overcome before we can create a synthetic consciousness?**

"There are some who believe that if we could emulate all the computational processes in the brain, one would then have also emulated consciousness as a phenomenon. But given that the human brain has nearly 100 billion neurons and many, many more synaptic interconnections, and the biological neuron is quite complex, it is virtually impossible that such an emulation can ever be done. Personally, I think the best bet for achieving conscious machines is via DNA-based systems, but it is unlikely society will ever explore this frontier due to its inherent dangers."

## Inside SubTropolis

The grid of extensive caves and tunnels revealed

**SubTropolis storage**  
Over 70 per cent of the building area is used by businesses involving warehousing and distribution.

**Transport network**  
The business park includes 13km of paved roads and 3km of railway.

**American football stadium**  
Drawn to scale for comparison

**Caves and tunnels**  
The underground industrial space is housed between 30.5 and 45.7m below the surface of Kansas City.

**Excavating rooms**  
Rooms are carved out of the solid stone and pillars are left as supporting columns to hold the thick limestone roof up.

**Security**  
SubTropolis is monitored 24 hours a day by CCTV and guards to make sure the complex is secure.

# Inside the city of caves

Welcome to SubTropolis: the underground business complex of Kansas City

Famed for its unrivalled barbecue cuisine and jazz heritages, Kansas City is the largest city in the state of Missouri. But beneath the water fountains and theme parks, under the feet of the population of almost 500,000 people, is an excavated mine spanning an area equivalent to 140 football fields located almost 50 metres below the surface.

Known as SubTropolis, the underground system is in what was a limestone mine. After the mine closed it left a network of empty tunnels. This would later become a new business district. Development began in the 1960s.

With over 55 companies and more than 2,000 employees working there today, it is estimated that ten per cent of business real estate in Kansas is in the SubTropolis. You might expect this to feel cramped, but with five-metre-high ceilings the tunnels are surprisingly spacious.

### GOING UNDERGROUND

The lower energy costs and cheap rent at SubTropolis

made the move underground attractive to businesses, and the thick walls of carved limestone offer another advantage. The temperature is always between 18 and 21 degrees Celsius – perfect for hosting computer servers and storing food. From national archives to the treasured old films of Hollywood, SubTropolis is always predictably cool and safe from any natural disasters that might hit the city.



SubTropolis is a hub for e-commerce and acts as both a storage and distribution site for companies



SubTropolis was created via the mining of its 270-million-year-old limestone deposits

## 5 FACTS ABOUT BUSINESSES AT SUBTROPOLIS

**1 Knapheide**  
Ford Transit and Ford F-150s are taken to SubTropolis for fitting after being assembled at the manufacturing plant a few minutes away from the complex.

**2 LightEdge Solutions**  
This is a cloud service company for businesses and a server storage facility that provides the power, security and connectivity they need to run.

**3 Underground vaults and storage**  
Hundreds of thousands of Hollywood reels are stored at SubTropolis to keep them safe and cool in order to prevent them from deteriorating and being ruined.

**4 Vanguard Packaging**  
This company prints supermarket displays and signs and moved into the complex to save money on heating and cooling bills and to provide a consistent temperature for their paper.

**5 Paris Brothers**  
The Paris Brothers use the caves as an underground coffee storage facility while they wait to be transported to a roasting facility – the dark, cool environment is perfect for the beans.

© Hunt Midwest, illustration by Adrian Mann

# Meet the prototypes

Japan House London explores the potential of cutting-edge technology to give us a glimpse of the future

Move over driverless cars, smart homes and the latest Apple technology: a vision of the real future has come to Japan House London. *Prototyping in Tokyo: Illustrating design-led innovation* brings to the Kensington High Street centre a series of innovative designs created by world-renowned design engineer and University of Tokyo Professor Yamanaka Shunji. The exhibition will explore the potential of prototypes to act as a link between cutting-edge technology and society.

This includes *Ready to Crawl*, a series of robots that are 'born' fully formed just like a living thing, with all of their parts created at the same time and fully assembled. Their form and movement is an uncanny mirroring of that of living things. Visitors have been learning the stories behind the prototypes. They are able to touch and interact with select displays, offering a glimpse of the structures and textures of the future.

There are three core themes to the exhibition. *Prosthetics* offers various interpretations of the 'expanded human body'. *Additive Manufacturing* takes prototyping to the next level with 3D-printing, which has allowed engineers and designers to create infinitely more complex prototypes with textures and the 'feeling of the future'. Finally, *Bio-Likeness Robots* goes beyond metal and motors, with Japanese researchers exploring the adding of life-like motion and behaviour to robots, giving the impression of intelligence. For example, the robot *Apostroph* examines the mechanisms that allow living organisms to stand.

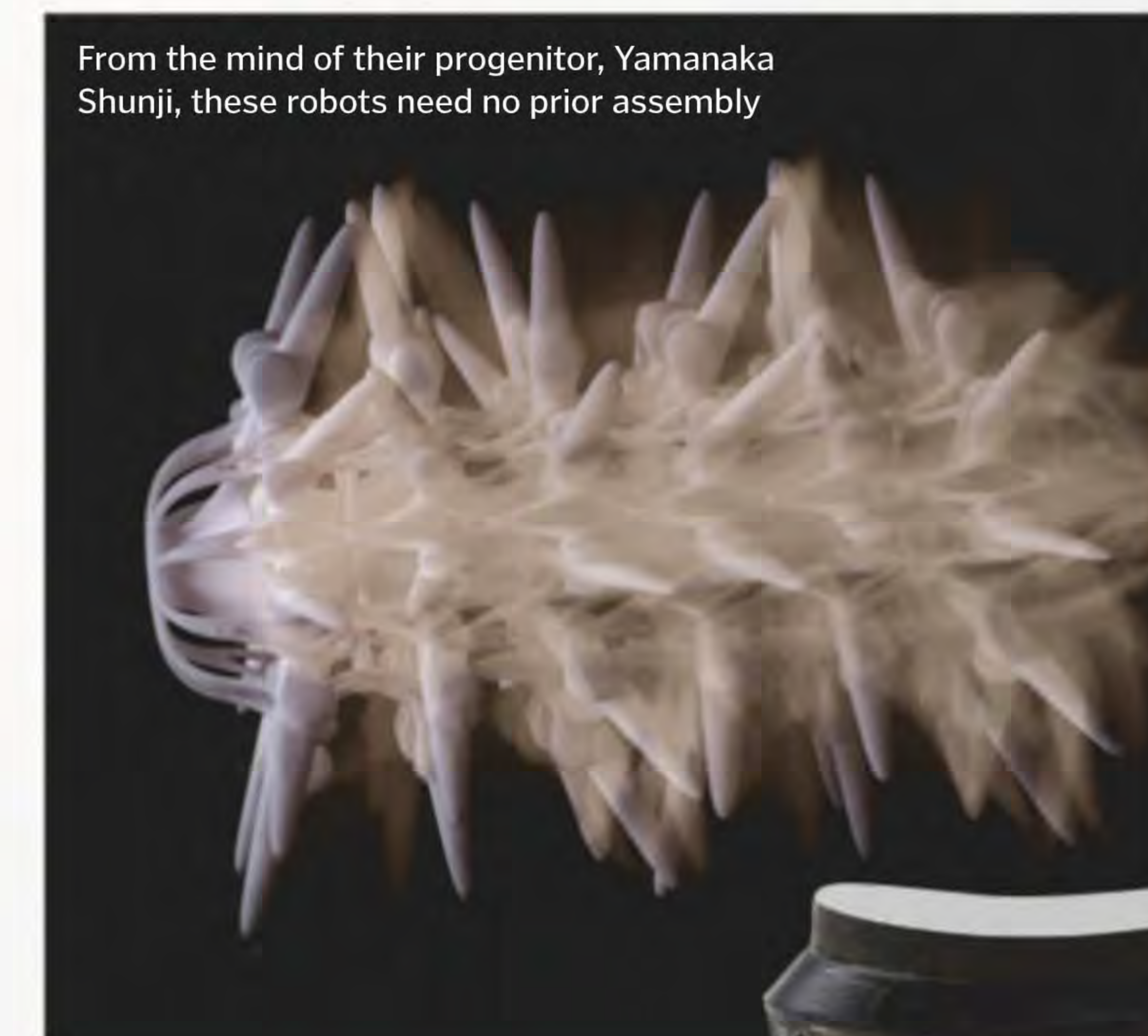

From the mind of their progenitor, Yamanaka Shunji, these robots need no prior assembly

LOCATION LONDON

DATE(S) NOW-17 MARCH 2019

HOURS MON-SAT 10AM-8PM

SUN & BANK HOLIDAYS 12PM-6PM

PRICE FREE

www.japanhouselondon.uk



The lifelike motion of *Apostroph* explores the mechanism that allows humans to stand and lends the robot the impression of intelligence

Shunji's sophisticated running prosthetics bring future technology and design aesthetics together

© Images KATO Yasushi



# LASERS IN SPACE

Interstellar spacecraft and asteroid-killing weapons are among some exciting possibilities for space lasers

Words by Jonathan O'Callaghan

**W**hen you think of lasers in space, you've probably got one thing on your mind – giant battles between fantastical spaceships, with explosions ringing out as good fights evil over a picturesque alien planet. In reality, we're perhaps not quite there yet (although who knows what the future might hold). But some of the ways we are actually using lasers already, and planning to do so in the future, are still just as awesome.

Lasers have been used in space since almost the dawn of the space age decades ago, when engineers on the ground used them to precisely measure the distance to orbiting satellites. This told them how high and how fast a satellite was moving; invaluable data that could create a global map of all the satellites orbiting Earth. Lasers can also be used by two spacecraft that are docking together, such as when a cargo spacecraft arrives at the International Space Station (ISS). This lets them know in rapid time how far the two vehicles are from each other.

More recently, lasers have found an entirely new use in space in the form of communications. Traditionally, spacecraft have communicated with Earth – or each other – using radio waves or microwaves. But these aren't great; they spread out over vast distances, making data-transfer rates frustratingly slow. They need a lot of power too, something that isn't readily available when you're heading deep into the Solar System.

Laser communication, on the other hand, can send much more data in a shorter amount of

time. In October 2013, NASA conducted a key test known as the Lunar Laser Communication Demonstration (LLCD) to prove just how useful it could be. It sent data back from lunar orbit to Earth at a rate of 622 Megabits per second (Mbps), which is over six times faster than comparable radio systems. Flown aboard a Moon-orbiting spacecraft called the Lunar Atmosphere and Dust Environment Explorer (LADEE), the experiment showed that laser communication could indeed be the gold standard for the future of spaceflight.

It's not just communications where lasers are making waves in space, either. Scientists use lasers on satellites to fire them onto Earth, letting them track extremely tiny changes in elevation on the surface, such as melting ice at the poles. In September 2018, NASA launched a satellite to do just that called the Ice, Cloud and land Elevation Satellite-2 (ICESat-2). Taking 60,000 measurements every second, it's able to track the changes in ice over Greenland and Antarctica down to just the width of a pencil. This gives us a key insight into how climate change is warming the planet and how much of our planet's ice we are losing.

Sure, you're saying, that's interesting, but it's not quite galactic space battles. Well, fear not, because some of the future uses of lasers in space could really blow your socks off. One in particular is gaining a lot of attention, and that's using lasers to push advanced spacecraft to huge distances, possibly to other stars, on interstellar

## Laser beacon

In November 2018, scientists from the Massachusetts Institute of Technology (MIT) proposed a novel way we could use to make contact with aliens. They suggested we could use a laser to create a giant 'porch light' on Earth, forming a beacon that could be seen from up to 20,000 lightyears away. To make the light, they proposed using a powerful laser and firing it through a huge telescope out into space.

The beam of infrared energy produced by the telescope would be bright enough that a distant alien race could tell that it was an artificial light and was not coming from our Sun. Aliens in nearby star systems a few tens of lightyears away could even enter into a conversation with us whereby these powerful beacons could be used to send Morse code-like messages. Interestingly, the researchers said we could do this with modern or near-future laser technology.



A laser beacon could be seen by aliens up to 20,000 lightyears away

## How a laser works

How do these seemingly simple devices create beams of light?

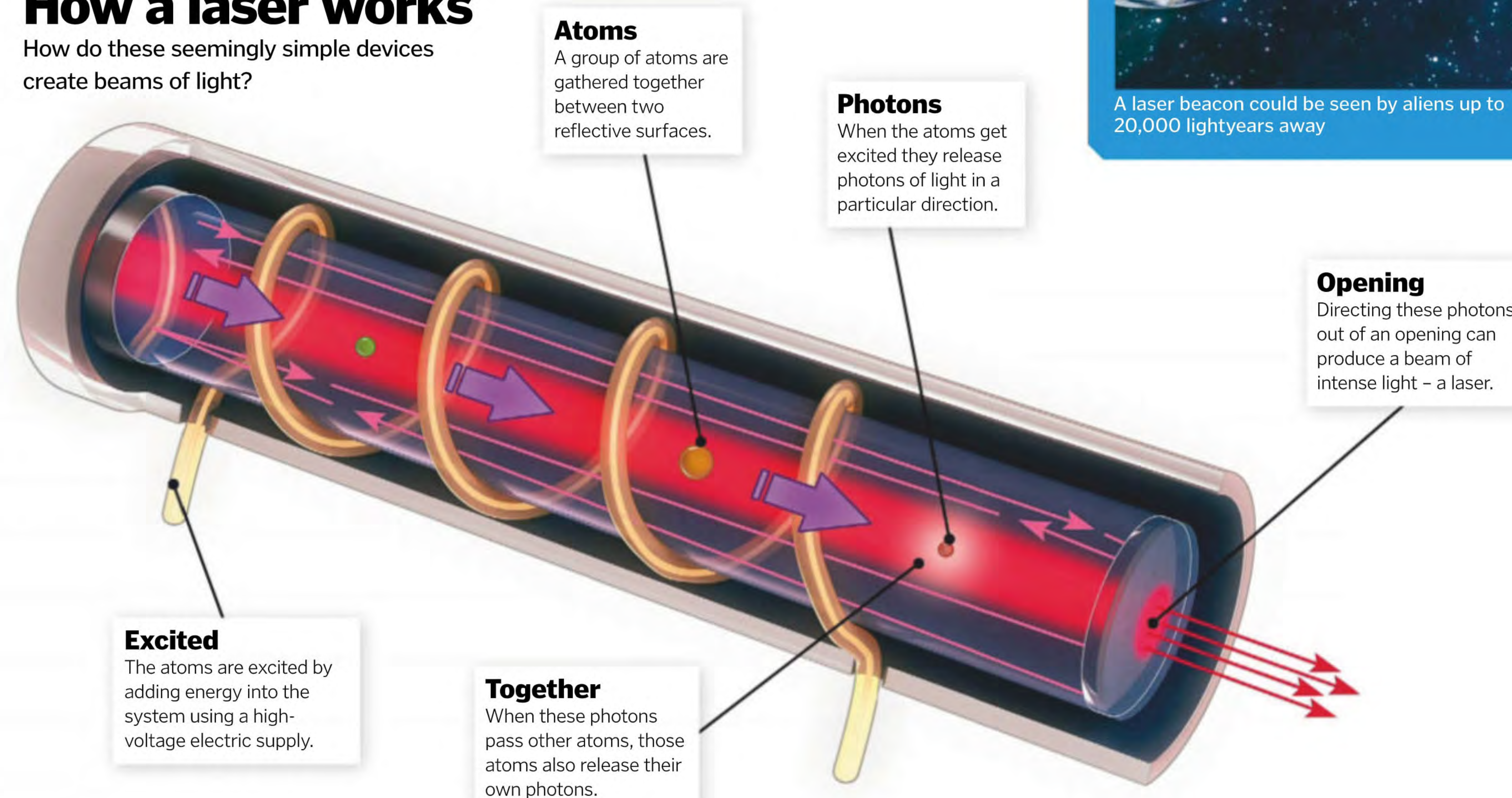



voyagers. Known as a light sail, these spacecraft would be super-thin, with a large sheet of material just 100 atoms thick. At their centre would be a small device weighing just a few grams containing all the instrumentation.

Firing a laser at these giant sails (which would span a football pitch or more), it could be possible to accelerate them to extreme speeds approaching the speed of light. This could make the travel time to nearby stars – such as Proxima Centauri at 4.2 lightyears away – more manageable. Conventional spacecraft using chemical propulsion would take several thousands of years to get there, but a light sail could make it to the star in a generation. This has inspired projects like Breakthrough Starshot, funded by Israeli-Russian billionaire Yuri Milner, which hopes to launch such a spacecraft in the coming decades.

Lasers could also provide a way for us to protect Earth rather than leaving it. For example, it might be possible to use a laser to heat the side of an asteroid that was headed our way. This effect would be tiny, but if done long enough in advance it could give the asteroid enough of a push that its path would change to miss our planet. In 2013, scientists from the University of California, Santa Barbara, US, even suggested it might be possible to use such a powerful laser to destroy an asteroid completely. They said a laser could be used to evaporate an asteroid's material, and even if it wasn't destroyed it could still be pushed out of our way. In one year, their idea – called DE-STAR – could obliterate an entire asteroid measuring 500 metres (1,640 feet) across.

Closer to home, scientists have also proposed that lasers could be used to get rid of some of the space junk orbiting our planet. By firing a laser at debris in orbit it would cause one side of the debris to heat up, changing its orbit and bringing it back into our atmosphere. With thousands of pieces of space junk orbiting our planet, this is thought to be a great way to start cleaning up some of the mess we've made.

If science is more your thing, check out the European Space Agency's (ESA) Laser Interferometer Space Antenna (LISA) idea. They want to launch three spacecraft in 2034 that would fire lasers between them. Monitoring tiny fluctuations in the lasers, they hope to find evidence for gravitational waves – ripples in space-time caused by huge events like colliding black holes – passing over the lasers.

So while we're not setting off to fight an evil alien civilisation with laser weapons just yet, we are finding some pretty amazing ways that lasers can be used in space. It might be that in the future our first visit to another star – or the first aliens from another star to see us – could be thanks to lasers in space.

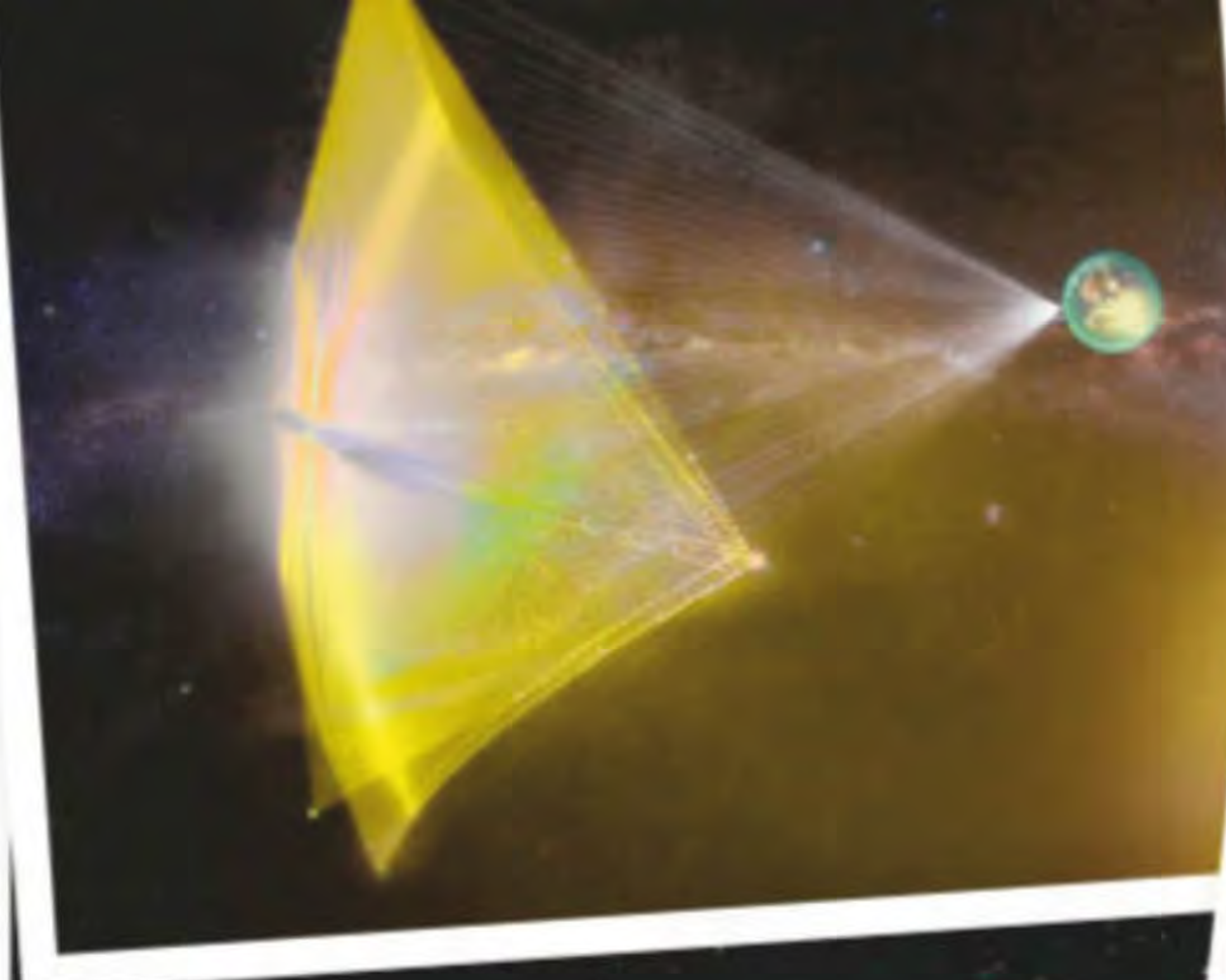

The Breakthrough Starshot project would use a light sail to reach another star

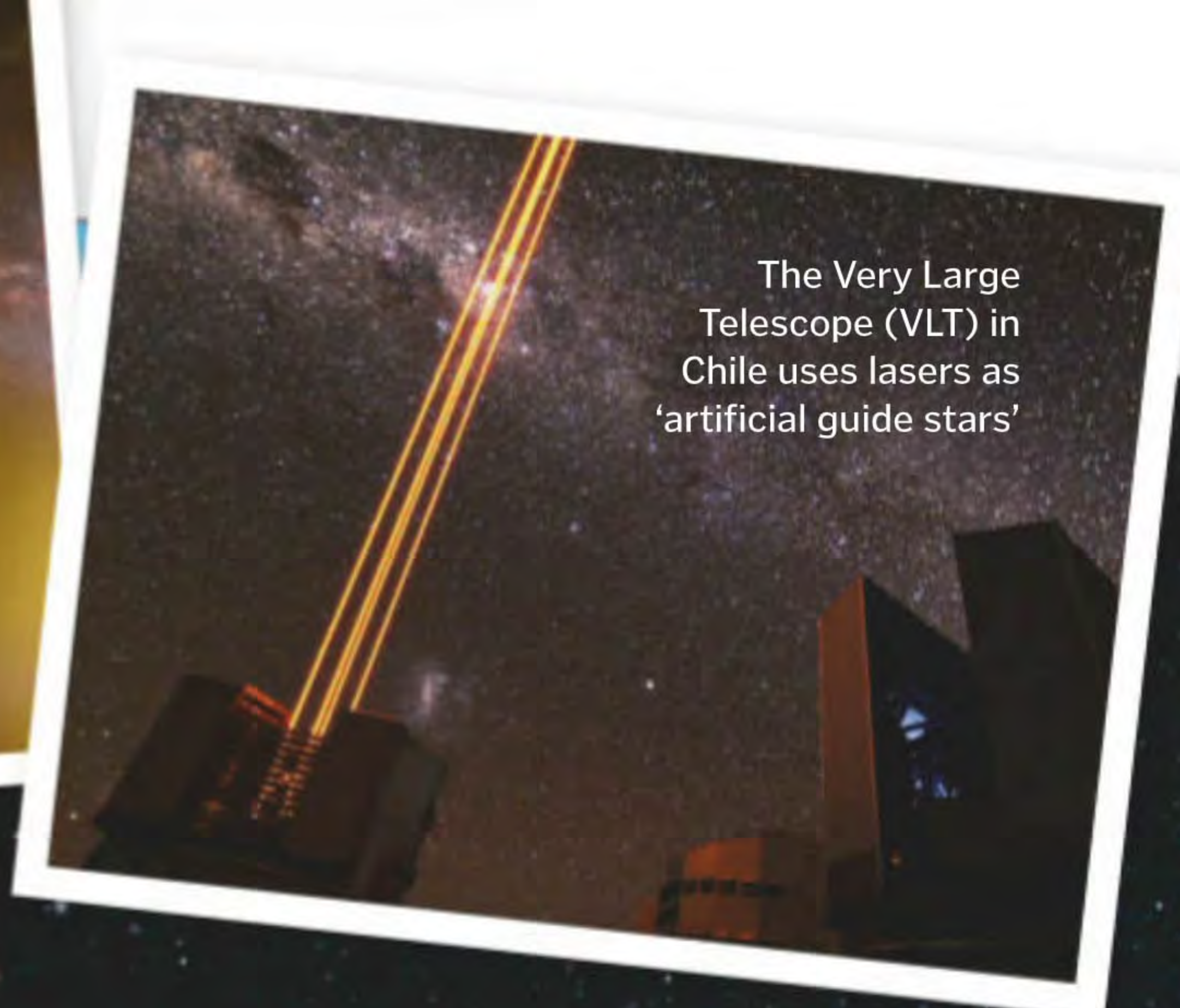

The Very Large Telescope (VLT) in Chile uses lasers as 'artificial guide stars'

# LASER APPLICATIONS

What are some of the different uses of these powerful beams of light?

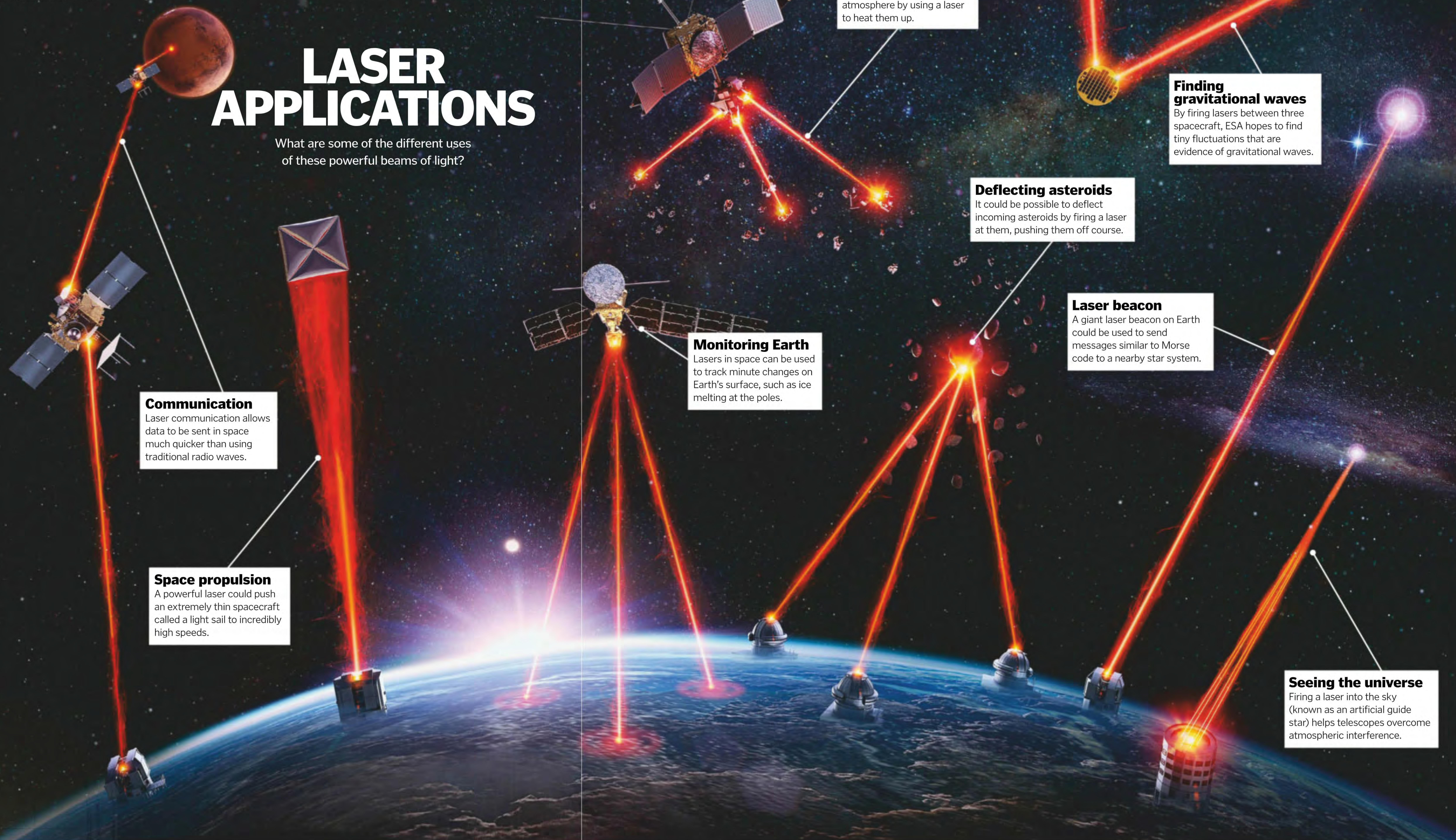

**Communication**  
Laser communication allows data to be sent in space much quicker than using traditional radio waves.

**Space propulsion**  
A powerful laser could push an extremely thin spacecraft called a light sail to incredibly high speeds.

**Monitoring Earth**  
Lasers in space can be used to track minute changes on Earth's surface, such as ice melting at the poles.

**Getting rid of space junk**  
Bits of space debris could be brought back into Earth's atmosphere by using a laser to heat them up.

**Deflecting asteroids**  
It could be possible to deflect incoming asteroids by firing a laser at them, pushing them off course.

**Finding gravitational waves**  
By firing lasers between three spacecraft, ESA hopes to find tiny fluctuations that are evidence of gravitational waves.

**Laser beacon**  
A giant laser beacon on Earth could be used to send messages similar to Morse code to a nearby star system.

**Seeing the universe**  
Firing a laser into the sky (known as an artificial guide star) helps telescopes overcome atmospheric interference.

**DID YOU KNOW?** The word 'laser' is an acronym for 'light amplification by the stimulated emission of radiation'

*"Our first visit to another star could be thanks to lasers"*



# What is string theory?

Could this strange idea explain how the entire universe works?

**S**tring theory, or more accurately superstring theory, is the idea that elementary particles like electrons are made up of vibrating strings of energy. While we once thought elementary particles were the smallest things possible, string theory suggests that there is something even smaller that makes up the universe around us.

The theory is also known as M-theory, and it's intended as a way to explain some of the limitations of the Standard Model of physics. This is the model we use to explain how everything in the universe works, but it breaks down when we look at things at a quantum level – the level at which weird effects take place, like particles appearing in two positions at once (called superposition) or being able to share information over great distances (called entanglement).

As the strings move through time they vibrate in one dimension in different patterns, or 'modes'. Each one of these can make the string appear like an electron, a photon, and so on. At bigger scales these strings simply look like particles to us. Some suggest string theory could be the much-sought-after 'theory of everything'. It can also explain how two particles of gravity, known as gravitons, can interact on large scales, when other theories cannot.

Not everyone believes in string theory, however. One notable problem is that it requires space-time to have at least ten dimensions, six more than our standard four: three for space and one for time. It's suggested that these extra six dimensions are so compact that we don't even know they're there. Plus, it's very hard to prove. We can't

really measure these strings, so how will we ever know that they exist? Nonetheless, string theory continues to be debated by the scientific community.

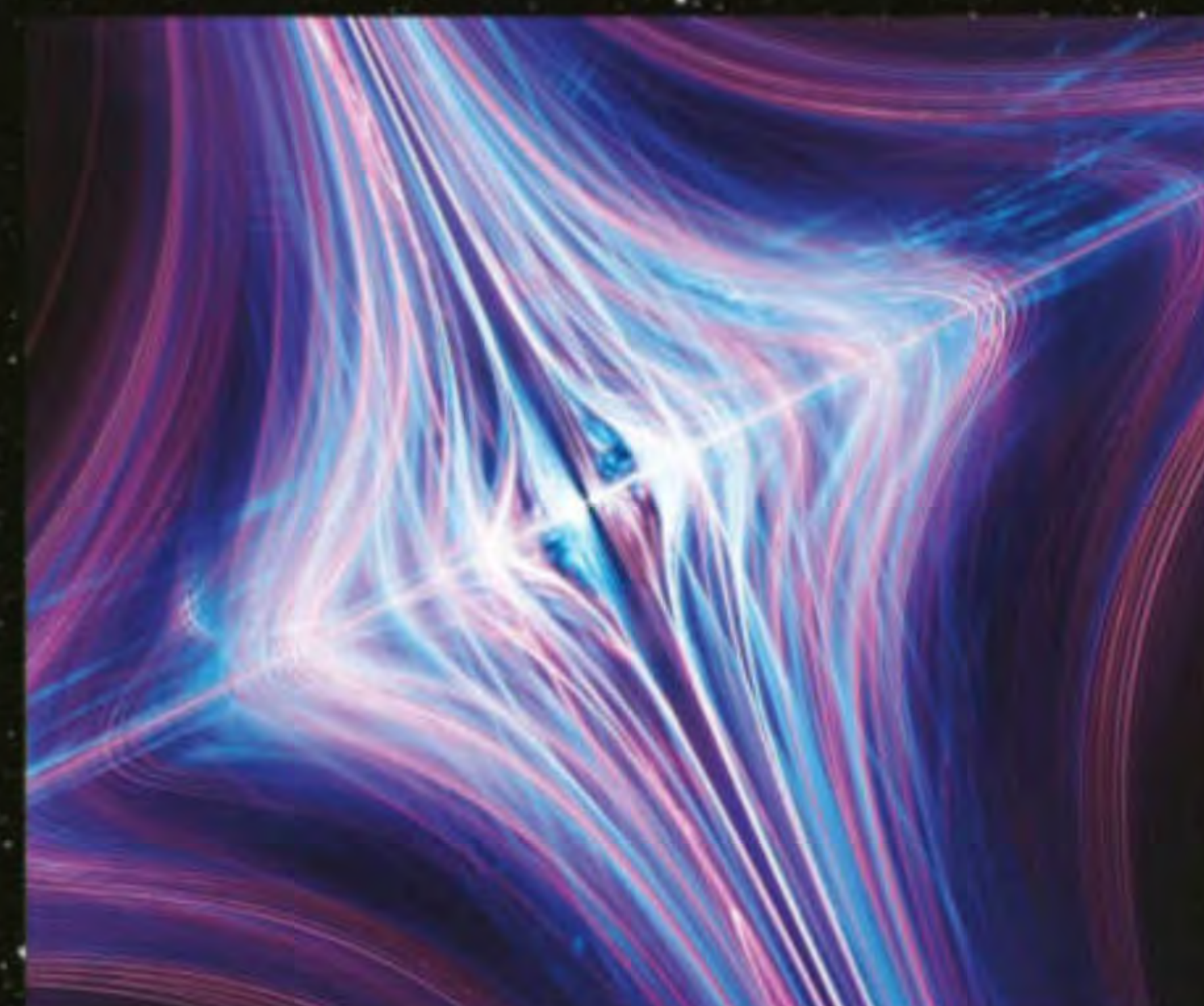

In string theory, everything is composed of vibrating strings of energy

## Breaking down string theory

Get ready – things are about to get complicated

### The graviton

String theory could help explain how gravity is able to take place at vast distances using particles called gravitons.

### Particles

As the vibrations move, they trace out 'tubes' that form things like electrons and photons.

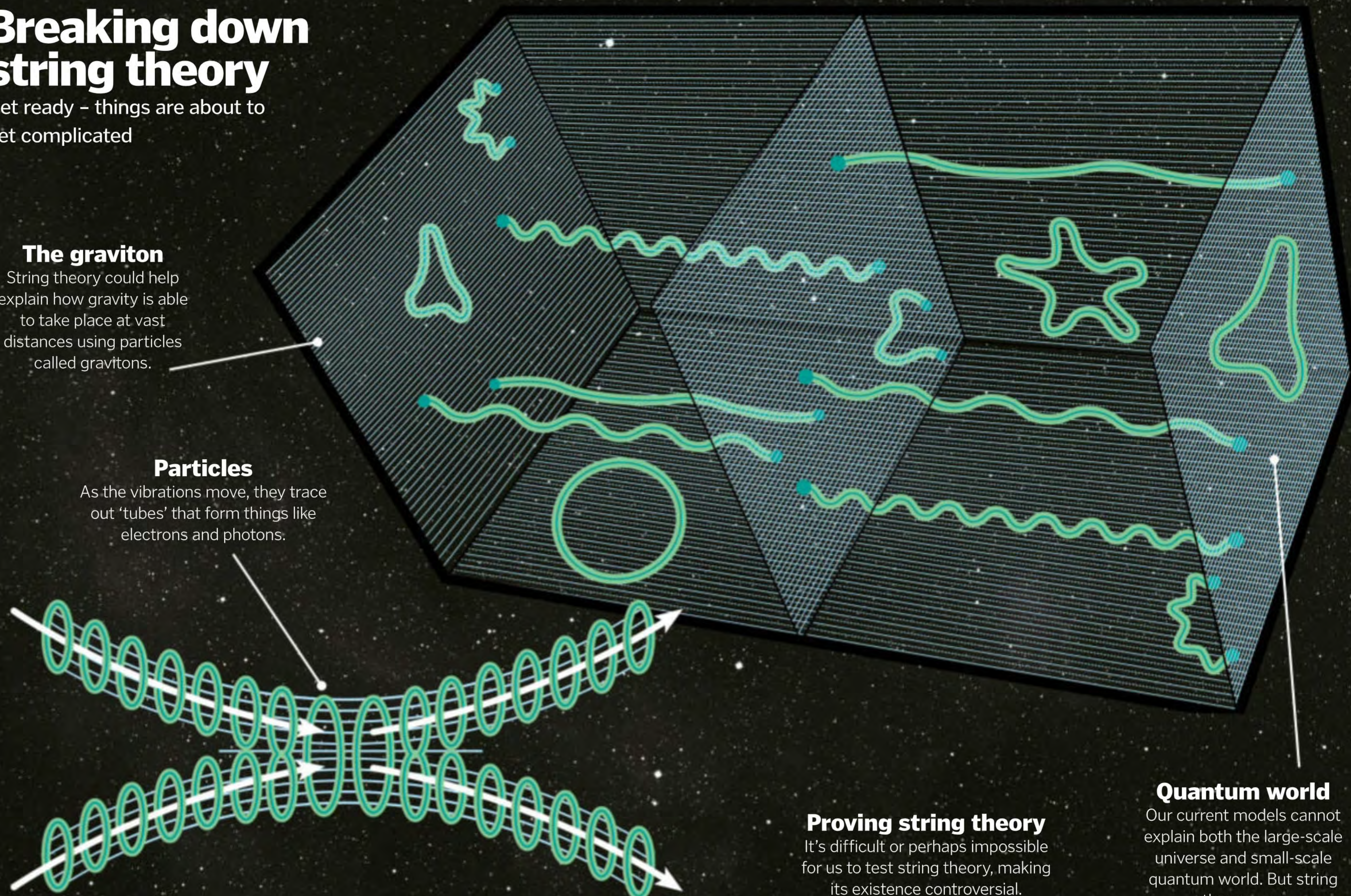

### Proving string theory

It's difficult or perhaps impossible for us to test string theory, making its existence controversial.

### Quantum world

Our current models cannot explain both the large-scale universe and small-scale quantum world. But string theory can.

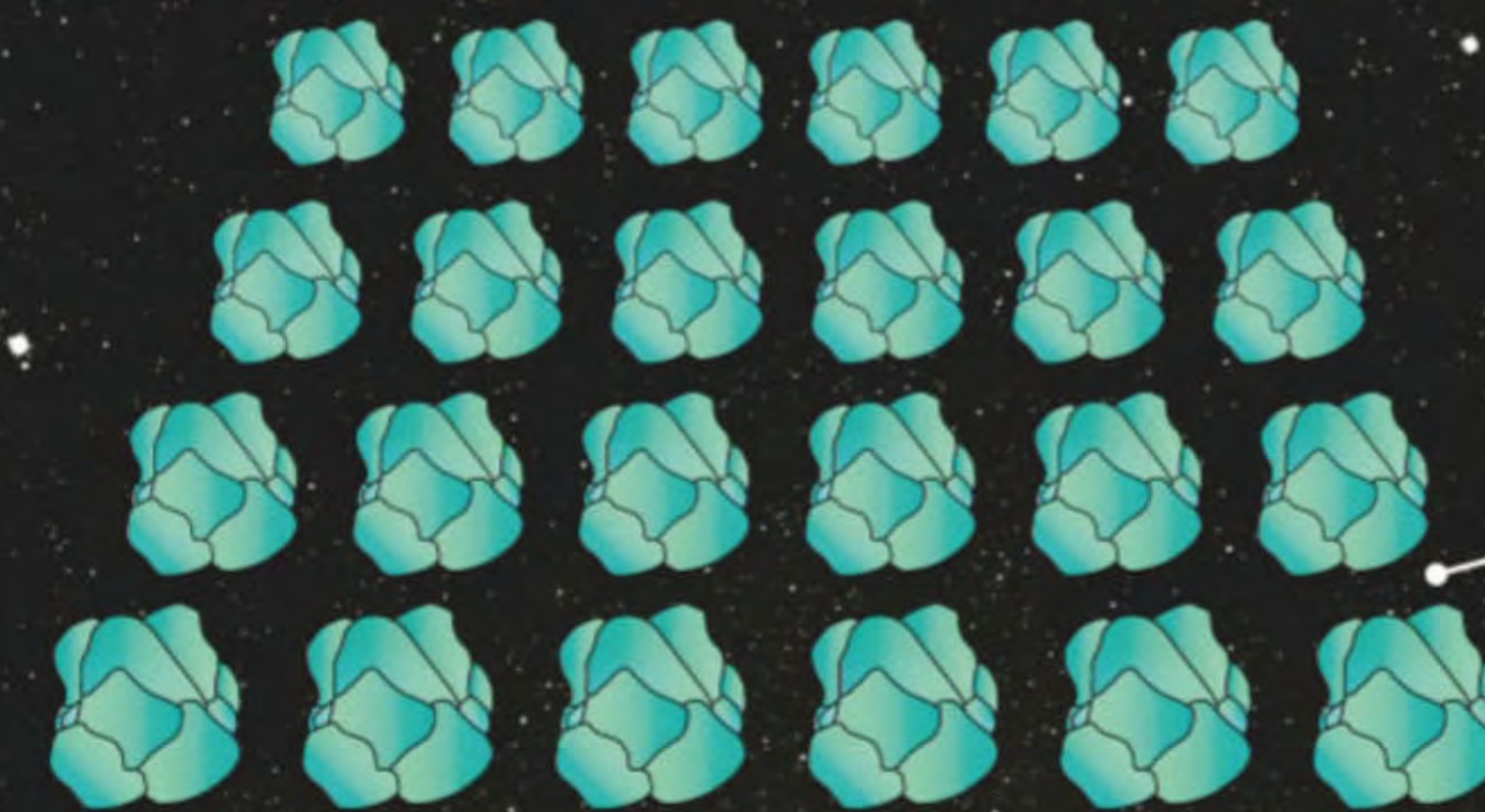

### Ten dimensions

We generally regard the universe as having four dimensions. String theory would require six additional dimensions to work.

"String theory could be the 'theory of

### Theory of everything

String theory could be a theory of everything, helping us understand how the entire universe works.

### Superstring

The 'super' in superstring theory refers to supersymmetry, a realm of physics beyond the Standard Model.

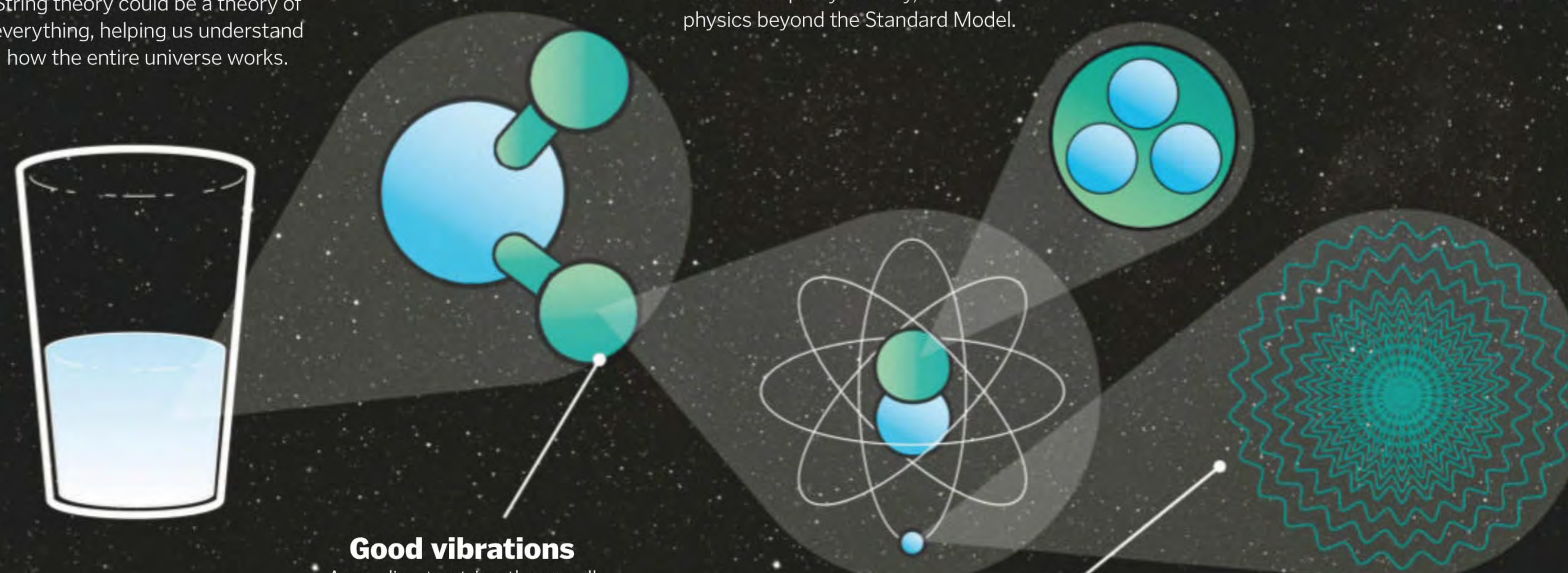

### Good vibrations

According to string theory, all particles can be broken down into vibrating strings of energy.

### Bad vibrations

But under string theory, these vibrations are so small that we can never actually see them.

### M-theory

Modern string theory is generally regarded as M-theory, which involves 11 dimensions.

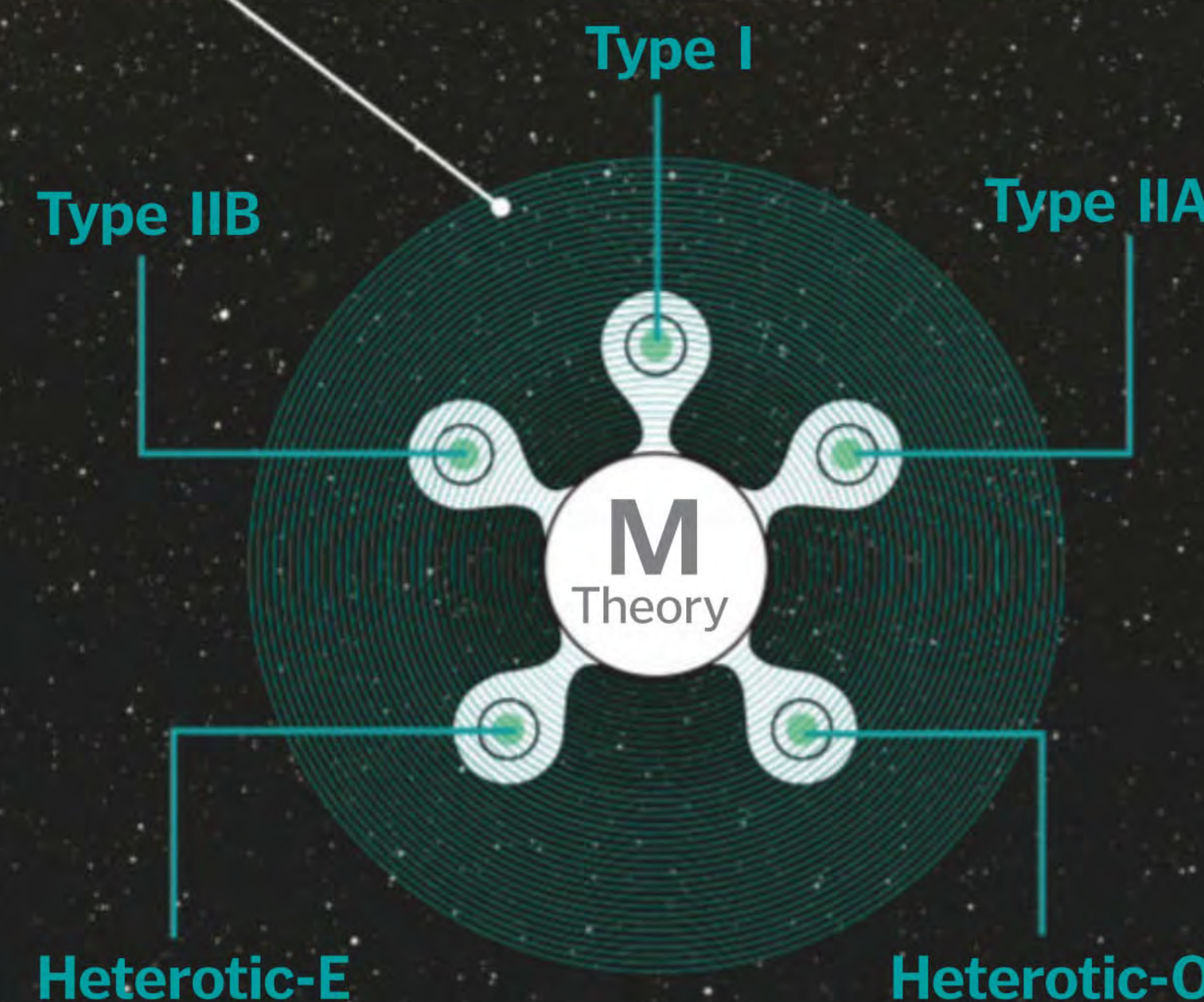

## Parallel universes

String theory isn't the only controversial theory on the block. Another is the many-worlds interpretation, which suggests that the universe has an almost infinite number of parallel universes. First put forward in 1957, it suggests that everything is quantum, meaning that things can occur in multiple ways simultaneously. If you apply this at both a small and a large scale, it means that all possibilities in any given scenario should occur, with each giving rise to a universe that is equally real. Under some versions of the theory it could actually be possible to see the effects of parallel universes on each other.



The many-worlds theory predicts there are near-infinite parallel universes

# SATISFY YOUR HUNGER FOR KNOWLEDGE WITHIN THE PAGES OF THIS BOOK!

Find out everything that you need to know about stimulating science, trailblazing transport, transformative technology, spectacular space, humorous history and the extraordinary environment!



**ON SALE NOW**

**DID YOU KNOW?** NASA's OSIRIS-REx completed its 2-billion-kilometre journey and arrived at asteroid Bennu in December 2018

## Exploring the Trojan asteroids

Discover Jupiter's massive asteroid neighbours, orbiting 750 million kilometres from Earth

Perfectly placed between Mars and Jupiter is a hurtling ring of rocks commonly called the main asteroid belt. As the leftovers from our Solar System's creation, these rocks are held in constant momentum by the Sun's gravitational force. However, around two astronomical units away from the belt (equal to a round trip from the Earth to the Sun) are swarms of rogue rocks called Trojan asteroids. They're named not after interstellar infiltrators into the Solar System but after the legendary Trojan Wars of Greek mythology.

First spotted in 1906 by German astronomer Max Wolf, these asteroids were discovered and named individually. Since then some 7,039 have been recorded and split into two groups: the Trojan camp and the Greek camp. The two groups occupy two of Jupiter's Lagrangian points. These are an area where the gravitational forces of two of the largest bodies in the Solar System meet, Jupiter and the Sun. Each planet or star has five of these special points, with the Trojan

asteroids trapped in the two most stable, which hold them in constant orbit, 60 degrees either side of Jupiter.

Asteroids are difficult to spot due to their small size and proximity to Earth and there is still a debate in the science community as to the origins of these Trojans. There may even be more asteroid swarms lurking in the Solar System that we just haven't spotted yet.



Two swarms of asteroids have been found orbiting the Sun either side of Jupiter

### Infiltrating the Trojans

To better understand the origins of these asteroids and potentially shed some light on the early Solar System, NASA is developing a satellite to infiltrate each camp and find some answers. Named after the skeletal remains of a human ancestor, Lucy is set to be propelled into space in 2021. Lucy's mission will be to make a 12-year journey to several Trojans and offer a close-up view of all three major types of bodies in the swarms. Two of these types resemble icy asteroids also seen in the Kuiper Belt, while the others are similar to the dark carbon asteroids in the main asteroid belt.

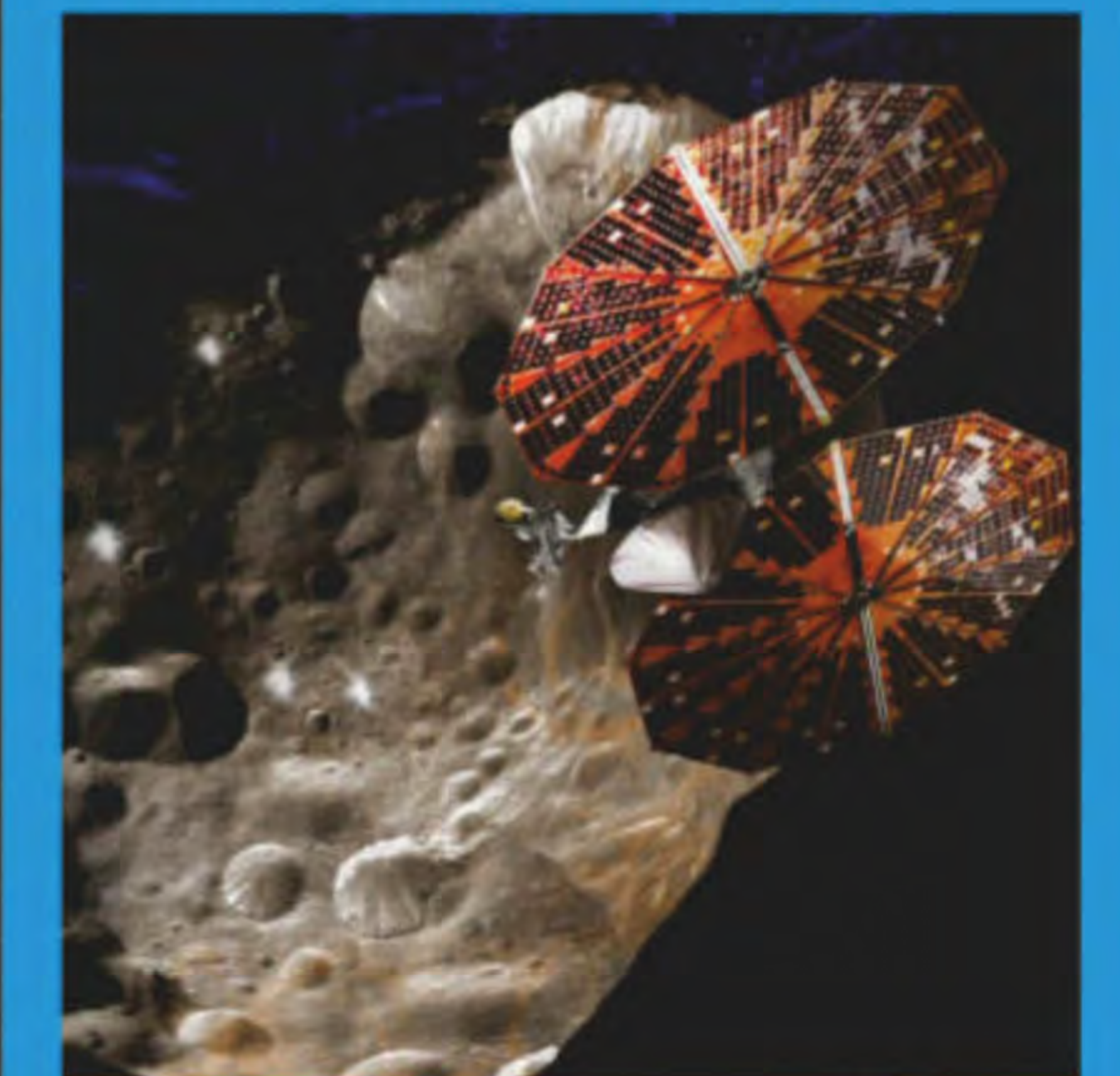

Lucy will be the first space mission to study Jupiter's Trojan asteroids

### Lucy's journey through space

Follow Lucy's course through the cosmos in search of asteroids

#### Greek camp

At the Greek camp there are around 4,600 Trojan asteroids recorded. This will be Lucy's first stop in 2027 before heading back toward to the Sun.

#### Individual targets

These are the locations of individual asteroid targets Lucy will be aiming for.

#### Pit stop

On returning from the first Greek camp, Lucy will pass by the Sun in order to reach the Trojan camp.

#### Trojan camp

At the Trojan camp there are around 2,439 Trojan asteroids recorded. This is the second destination in Lucy's journey, a point Lucy will reach in 2033. Once data is collected from these asteroids Lucy will journey between each camp every six years.

#### Lucy

This is the trajectory Lucy will make around the Sun to reach both asteroid camps. After launch from Earth Lucy will orbit the Sun twice before heading to the first swarm of Trojan asteroids in the Greek camp.

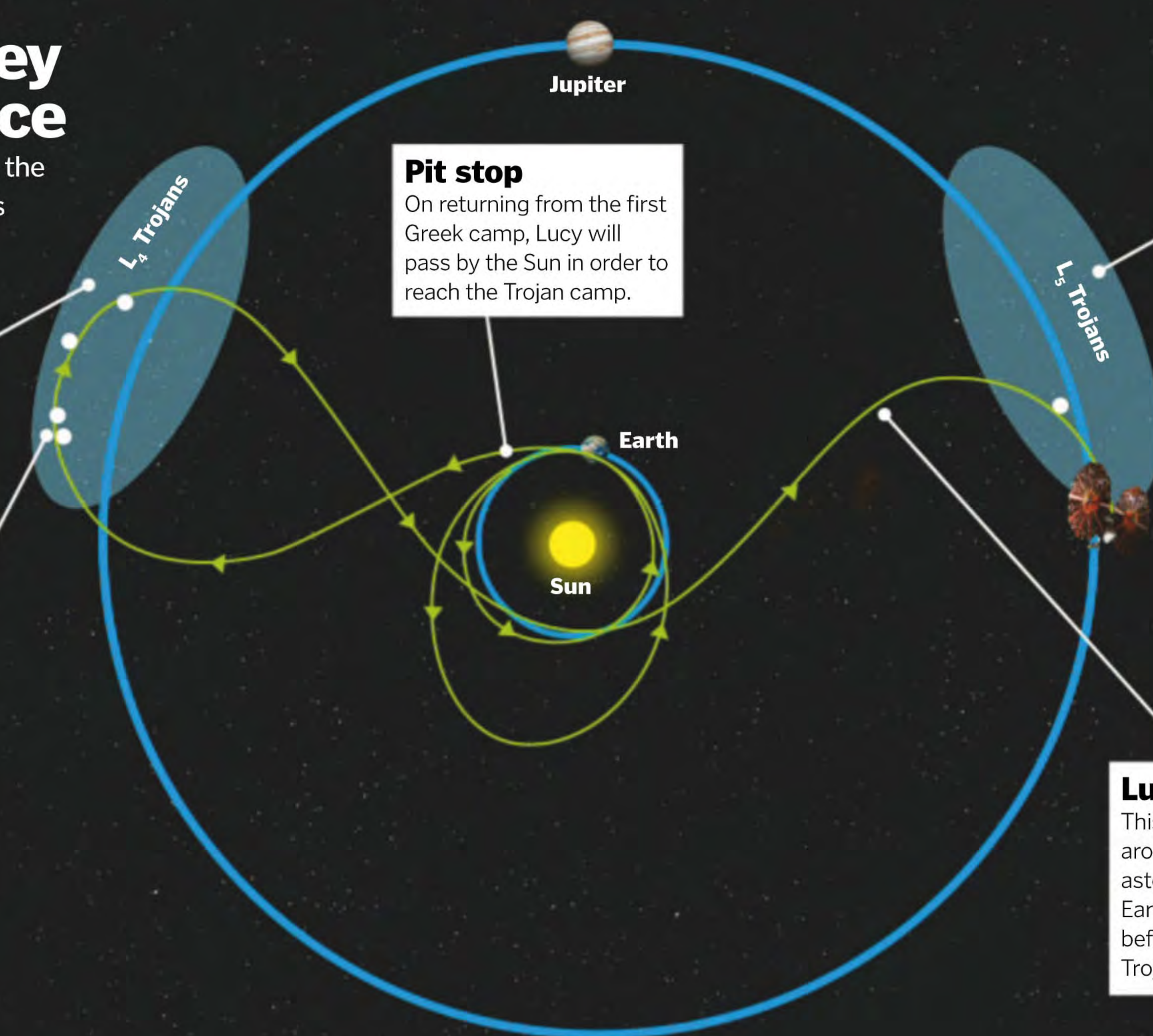

Ordering is easy. Go online at:  
**www.myfavouritemagazines.co.uk**  
Or get it from selected supermarkets & newsagents



# How the Battle of Waterloo was won

Words by Tim Williamson

When Napoleon Bonaparte returned from exile to reclaim his empire, standing in his way were two determined coalition armies

In 1814, Napoleon Bonaparte, Emperor of France and conqueror of Europe, was finally defeated and exiled to Elba in the Mediterranean Sea. However, just over ten months later, he escaped his island prison and landed on the south coast of France on 1 March 1815 to reclaim his lost empire. He quickly gathered supporters, and armies sent by King Louis XVIII to challenge him quickly changed sides, declaring their loyalty to the returned emperor. The news of Napoleon's return shocked the continent and before long, a new coalition of European nations was lined up against him. Both the Duke of Wellington, commanding an Anglo-Allied force, and Gebhard Leberecht von Blücher, leading a Prussian army, moved to intercept the French, who were mounting an invasion of Belgium.

Wellington knew he could not defeat Napoleon's army alone. The French slightly outnumbered his Anglo-Allied force, which was made up of British, Dutch, German and Belgian troops, plus a number of men from other nations. Further to the east, Blücher commanded roughly 115,000 men, which would be enough to tip the balance against Napoleon – if only the two armies could reach each other in time. Realising this, Napoleon was determined to drive a wedge between his enemies, using his superior numbers to defeat each in turn.

On 16 June, this strategy almost worked. At around 2pm, French Field Marshal Michel Ney attacked Wellington at Quatre Bras, the location of a vital crossroads along the road to Brussels. Further east at Ligny, Blücher was attacked by Napoleon and forced to retreat north. Napoleon ordered one of his generals, Marshal Emmanuel de Grouchy, to pursue the Prussian force closely, while he returned to Ney at Quatre Bras, who had allowed Wellington to escape.

Withdrawing north, the Duke halted on the night of 17 June and headquartered in the village of Waterloo. Not far behind, Napoleon and his army made camp further south, and the Emperor rested at a farm called La Caillou. Heavy rainfall all through the night soaked both armies and turned much of the ground between them into a muddy quagmire. This would prove critical the following morning.

Waking with full confidence, Napoleon declared to his generals that defeating Wellington would be "as easy as having



'Scotland Forever' - an 1881 painting by Lady Butler depicting the charge of the Scots Greys during the battle

### Emperor Napoleon Bonaparte

Born on the Mediterranean island of Corsica in 1769, Napoleon travelled to France during the revolution, serving as an artillery officer. His tactical awareness and leadership were soon apparent, and by 1796 he was in command of an army and leading a campaign in Italy. In 1799, after returning from campaigning in Egypt, Napoleon seized control of the disorganised government in Paris and later in 1804 crowned himself Emperor of the French. As Emperor, he established the Bank of France and passed widespread law reform, much of which has survived centuries. He also gave powerful positions to many of his close family, including crowning his brother Jerome King of Italy. He married his second wife, Marie-Louise, in 1810, and his son, Napoleon II, was born in 1811. After his final defeat at the Battle of Waterloo the Emperor abdicated and was later exiled to the South Atlantic island of St Helena, where he died in 1821.



Napoleon, painted in military uniform, in his study at the Tuileries Palace

breakfast". Wellington, meanwhile, had been surveying his battle lines with his staff, identifying the key positions (three farmhouses) that his troops would have to hold. He deployed a majority of his men and cannons behind the raised ridgeline of Mont-Saint-Jean, which was an advantageous position to defend.

At 11am he ordered Marshal Honoré Charles Reille's II Corps to occupy the woods close to the farmhouse of Hougomont. Men of the Coldstream Guards and Nassau regiments were garrisoned in this building and its adjoining orchard and garden. The defenders had created holes in the walls of the courtyard through which they could fire on the enemy.

Although Napoleon only intended this attack as a diversion to distract Wellington from the main French offensive, it soon became a costly bloodbath as the attack turned into an all-out assault to take Hougomont. At one critical point a number of French soldiers broke into the building's courtyard through the north gate. Lieutenant colonel James Macdonell, the

garrison commander, rallied his men and managed to shut the gate on the enemy.

The struggle for Hougomont would last for the rest of the day. Perhaps due to fierce artillery bombardment, parts of the compound were set on fire. Seeing this, Wellington ordered his men to occupy and defend the ruins - he knew Hougomont had to be held at all costs.

While Wellington's right flank endured wave after wave of attacks, the centre-left of his battle line was soon under pressure. At around 2pm the French I Corps, commanded by the Comte d'Erlon, began its advance against the farms of La Haye Sainte and Papelotte, advancing up the ridgeline toward the waiting defenders.

Approximately 17-20,000 French infantrymen advanced in huge columns, beating drums and cheering 'Vive l'Empereur!' ('Long live the emperor!'). Once they reached the brow of the ridge they were met with horrific volley fire from the British and German battalions.

The Duke had stretched his infantry holding the ridge - approximately 3,500 men - into three ranks of up to 150 soldiers wide. This gave the defenders as much firepower as possible to halt the French advance. Most soldiers were armed with a 'Brown Bess' flintlock musket, which had an effective range of just 40 to 50 metres (131 to 164

feet). As these firearms were very inaccurate, a massed volley of shots was the most effective way of inflicting casualties.

Once the distance between the two forces had closed, the 5th Division commander General Thomas Picton ordered his men to fix bayonets and charge the

French, crying, "Charge! Charge! Hurrah! Hurrah!" The general was killed instantly, but his counterattack drove the French back.

Watching these events unfold was Lord Uxbridge, commander of the British cavalry. Seeing an opportunity, he ordered a massive cavalry charge, which successfully destroyed d'Erlon's advance. Hundreds of men were cut down or sent fleeing by the cavalry, which gained momentum as the horses galloped down

*"At one point French soldiers broke in through the north gate"*

### How the battle unfolded

Blow-by-blow, from the first shots until the final victory

#### 01:00-03:00 Night deployment

The two armies make camp - Napoleon sets up his headquarters at La Caillou farm in the south and Wellington finds quarters in the village of Waterloo to the north.

#### 09:00 Delayed attack

With heavy rain overnight, Napoleon decides to wait for the battleground to dry out before beginning his attack.

#### 11:20-11:30 Grande Batterie opens fire

The French cannons begin firing on the Anglo-Allied positions, who promptly return fire. French infantry begin advancing on Hougomont.

#### 12:00-13:20 All-out assault

French infantry continue to attack Hougomont on Wellington's right flank, while around 17-20,000 men of d'Erlon's Corps march against the left flank.

#### 14:00-14:45 British cavalry charges

Seeing an opportunity, the British Union and Household Brigades charge the French line, capturing two regimental eagles in the assault as their horses smash into French infantry.

#### 16:00-18:00 French cavalry charges

After repulsing the charge, over 4,500 French heavy cavalry gather to counter-attack. They charge over the ridgeline and into British infantry arranged in square formation.

#### 16:00-21:00 Prussians attack Plancenoit

Arriving to the rear and right of the French formation, Prussian infantry assault the French garrison in the village of Plancenoit - horrific close-quarters combat ensues.

#### 18:30 The French capture La Haye Sainte

After hours of brutal fighting, the farmhouse of La Haye Sainte in the centre of Wellington's line is finally captured by French infantry, dealing a serious blow to the Duke's hopes of victory.

#### 20:00 Napoleon is defeated

A final desperate attack by the French Imperial Guard is repulsed by merciless British volley fire. The elite troops withdraw and soon Napoleon's army is in full retreat, the Emperor's dreams of triumph crushed.

the slope, where the French infantry had only recently marched.

Although a decisive moment, this charge came at a huge cost. Many cavalrymen continued to gallop across the field toward the French cannons, where fresh French cavalry quickly counter-attacked and inflicted heavy casualties on the tired British.

With the British cavalry all but eliminated, the French cuirassiers, or heavy cavalry, were ordered to attack the Anglo-Allied infantry over the ridge. Ordinarily, cavalry held a huge advantage over foot soldiers, especially when attacking thin lines of men, who would often panic, break ranks and be easily chased down. However, what Napoleon and his generals could not see over the ridgeline of Mont-Saint-Jean was that Wellington had arranged his infantry battalions into 24-by-30 square formations. Each square presented bayonets and muskets pointed outward at every side, posing an impossible obstacle for cavalry to break. Nonetheless, the French horses swept over the ridge and poured in among the formations, seeking any gap in the lines. For two hours the French charged back and forth over the ridge to try and destroy the

British formations, which held, the horsemen caught in deadly crossfire.

From around 4.30pm Napoleon had even more troubling news to contend with. Through his telescope he could now see the Prussian army approaching on his right and to his rear. Around 30,000 men of the Prussian IV Corps, commanded by Friedrich Wilhelm Freiherr von Bülow, were advancing on the village of Plancenoit. If they could take this position it would spell disaster for the French.

Spotting the threat, Napoleon committed ten battalions (around 6,000 men) of his Imperial Guard to help defend Plancenoit. These elite infantry reserves were a formidable opponent, and the fight for the village turned into a bloody struggle that lasted into the evening.

With the Prussian army outflanking him and Wellington's battered infantry seemingly holding firm, the battle was all but lost for the emperor. Determined, and perhaps desperate, he nonetheless made one last bid for victory, ordering his remaining elite Imperial Guard to advance on Mont-Saint-Jean.

By 6pm the French had finally captured La Haye Sainte, a huge blow to Wellington. Despite

the arrival of his ally on the battlefield, the Duke knew his men were close to breaking. Low on ammunition and with scores of casualties, the Anglo-Allied lines nonetheless formed ranks one last time to defend against the Imperial Guard. Dutch, Belgian and British volley fire at close range devastated the French, who advanced in square formation to protect against cavalry. A cry of 'La garde recule!' ('The guard retreats!') went up as the guardsmen hastily withdrew.

By the late evening the French were in full retreat, and before the end of the month Napoleon had abdicated. Wellington and Blücher greeted one another on the battlefield that evening. Wellington would later refer to the battle as "the nearest run thing you ever saw in your life."

### Arthur Wellesley, Duke of Wellington

The third son of an Irish nobleman from County Meath, Arthur Wellesley was born in Ireland in 1769. After moving to England, Wellesley attended school in London then went to Eton College. In 1787 his elder brother, the Earl of Mornington, bought him an officer's commission in the British Army, and he departed to serve in India. Largely through his family's influence, Wellesley purchased several quick promotions through the ranks and by 1793 was lieutenant-colonel of his own regiment. After service in Holland and India he was given command of the British expeditionary force to Portugal and Spain. It was during this period that Wellesley achieved many of his greatest victories, and for his success he was made Duke of Wellington. After Waterloo he served twice as Prime Minister before his death in 1852.



The Duke, painted 1815-16 by Thomas Lawrence (1769-1830), wearing his Field Marshal's uniform

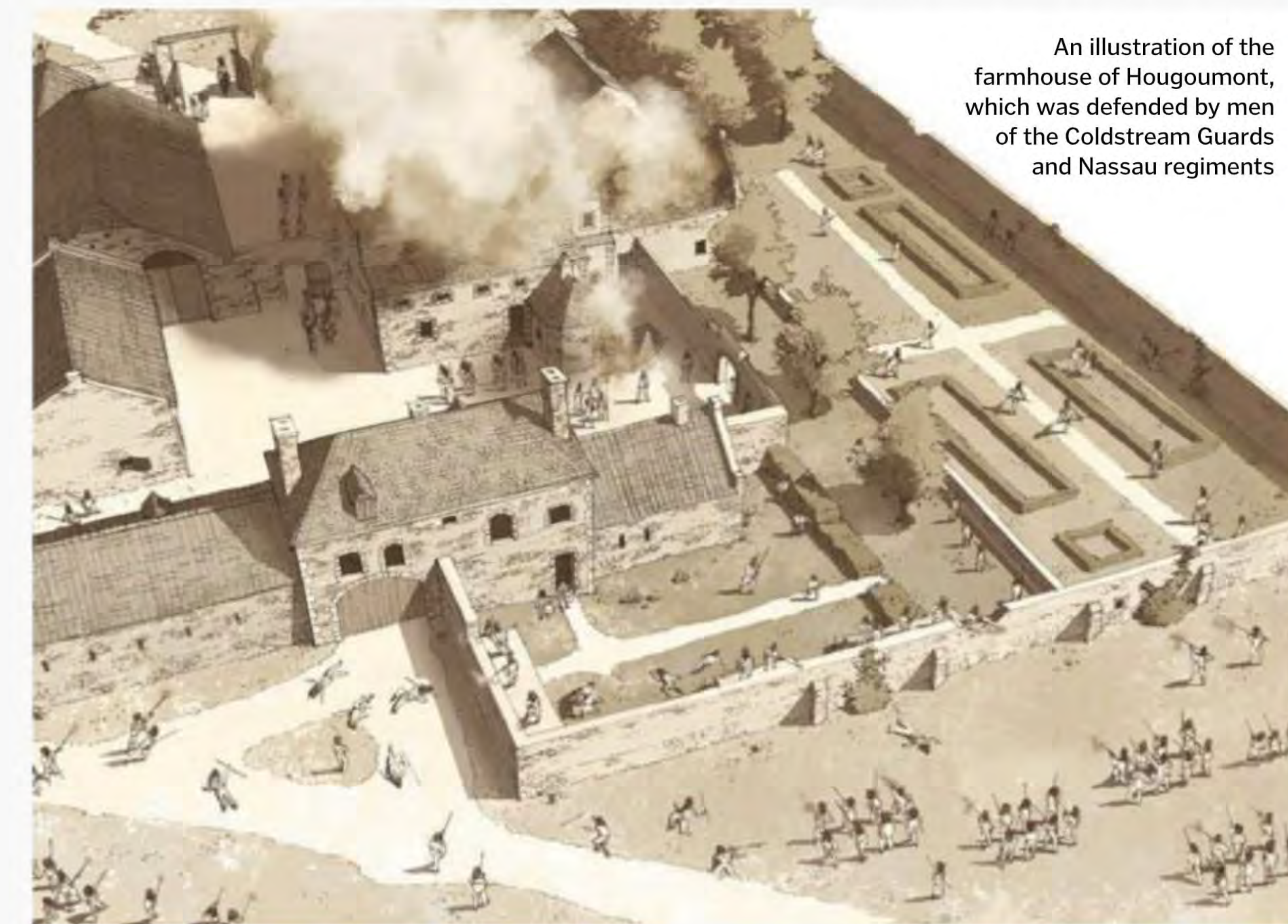

An illustration of the farmhouse of Hougomont, which was defended by men of the Coldstream Guards and Nassau regiments



# The Battlefield

The Battle of Waterloo took place within rain-soaked crop fields and farmhouses



### Wellington's deployment

The Anglo-Allied army holds three farmhouses: Hougoumont, La Haye Sainte and Papelotte. A majority of the infantry are situated atop an elevated ridge.

### French cavalry charge

Armed with swords and lances and heavily armoured, Napoleon's cavalry is successful against their British counterparts but is unable to break Wellington's infantry formations.

### Infantry squares

When facing French cavalry charges, Wellington's infantry forms tight ranks of elongated squares, presenting musket fire and bayonets to prevent the units being outflanked and scattered.

### The Hougoumont farmhouse

Napoleon's first objective is to take the small compound at Hougoumont. Lightly defended by only a few allied companies, a mass infantry attack is repulsed just as the men in the courtyard near breaking point.

### The diversion becomes a mass battle

The French army is determined to take Hougoumont, believing that if they do Wellington's reserves will be drawn towards it and leave his centre exposed. Napoleon's eager brother Jerome commands the attack on the farmhouse.

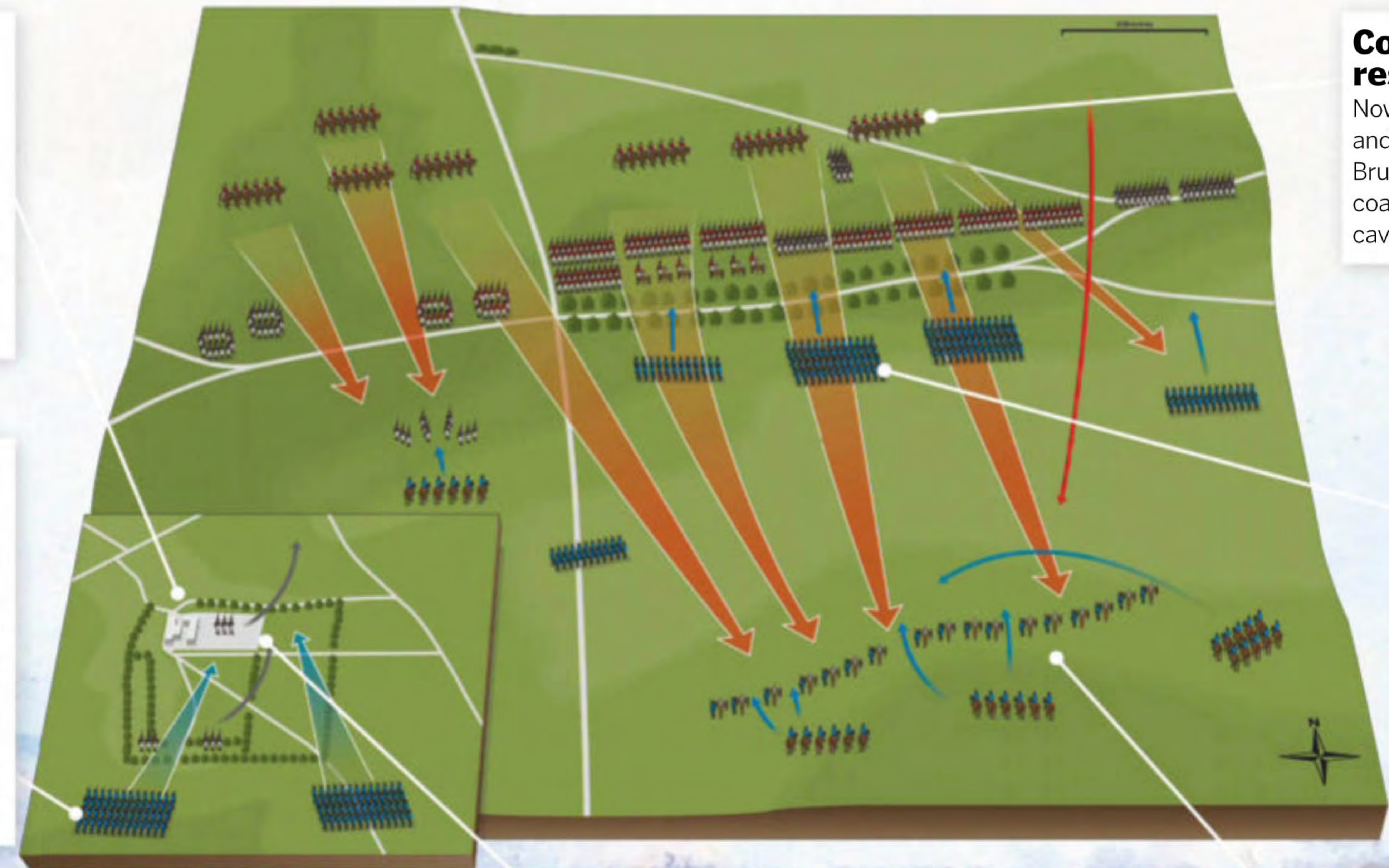

### Coalition cavalry response

Now low on reinforcements and thinly spread, the road to Brussels is opening, but as the coalition infantry stumble a cavalry charge rescues them.

### D'Erlon's advance

After the artillery barrage, Napoleon sends in his infantry. 17-20,000 Frenchmen led by d'Erlon rush into La Haye Sainte as the defenders, including members of the 95th Rifles and King's German Legion, are forced back.

### Resolute coalition defence

The 2m wall that surrounds the compound is stubbornly defended by the British, who fire their muskets and rifles through any gaps in the wall they can find. They hold out despite waves of French attacks.

### The main assault

The Grande Batterie lines up in the middle of the field and fires countless bursts of round shots. The bombardment lasts for two hours and the allied lines are peppered with cannon shot.

### The Prussians arrive

With the arrival of the Prussian army on his right flank, Napoleon sends his Imperial Guard to break Wellington's line - they fail and the battle is lost.



The pillars on which Lincoln's hands rest are fasces, wooden bundles associated with power

Approximately 40% of the Lincoln Memorial is located underground



**DID YOU KNOW?** The columns and exterior walls of the memorial lean slightly inward to compensate for perspective distortions

# The Lincoln Memorial

## Why was the 16th president honoured with a memorial that looks like a Greek temple?

**S**trength, wisdom, fortitude – for many, United States president Abraham Lincoln embodied all those qualities, so when he was brutally assassinated in 1865, plans for a memorial in his honour began immediately. However, years of disagreement over the project meant that construction didn't commence for nearly 50 years.

The finished temple-like building stands at 30 metres (98 feet) tall, a dominating feature of the nation's capital, Washington, DC. Architect Henry Bacon drew inspiration for his design from the Parthenon in Athens. He felt it was fitting to honour a man who defended democracy with a structure from the very birthplace of democracy. And the symbolism doesn't end there. The building's 36 columns represent the states of the Union at the time of the president's death, with the entire memorial constructed from stones from different parts of the United States to convey the importance of the Union to Lincoln.

The enormous statue of the man himself was carved from Georgia marble and took four years to complete. It was designed by Daniel Chester French, who studied photographs and

eyewitness accounts from the Civil War to get the facial expression just right. The statue sits in the central hall, which is separated from two other chambers by rows of columns. More than just decorative, these provide structural support for the ceiling.

Great care had to be taken to ensure the walls and foundations were strengthened, due to the marshy terrain. The ground had to be drained and filled, and 122 solid concrete piers (cylindrical columns) with steel reinforcements were rooted into the bedrock. Above that is a second series of piers, joined together with concrete arches to form the memorial's floor. More supports were added when the Lincoln statue doubled in size to 5.79 metres (19 feet).

In 1922 the memorial opened to the public as a shrine, a museum and a place of pilgrimage for millions of visitors.

*"The 36 columns represent the states of the Union at the time of the president's death"*

## Murals and meanings

Behind the larger-than-life Lincoln statue are the words, "In this temple, as in the hearts of the people for whom he saved the Union, the memory of Abraham Lincoln is enshrined forever." Written by *New York Herald Tribune* art critic Royal Cortissoz, the inscription sums up the purpose of this impressive structure. This is accompanied by inscriptions of two of the president's most famous speeches on the north and south walls.

The Gettysburg Address was delivered during the American Civil War in 1863 and showed the president's determination to reunite the nation. The other is the Second Inaugural Address – delivered in 1865 just before the end of the Civil War – which asked people of the Union to show "malice towards none; charity for all." Above each inscription is a large mural painted by Jules Guérin. They depict the Angel of Truth releasing slaves and joining the hands of two figures in unity respectively. The paint was mixed with kerosene and wax to protect them from the temperature and moisture, preserving them for years to come.



Part of a mural above the Gettysburg Address in the Lincoln Memorial

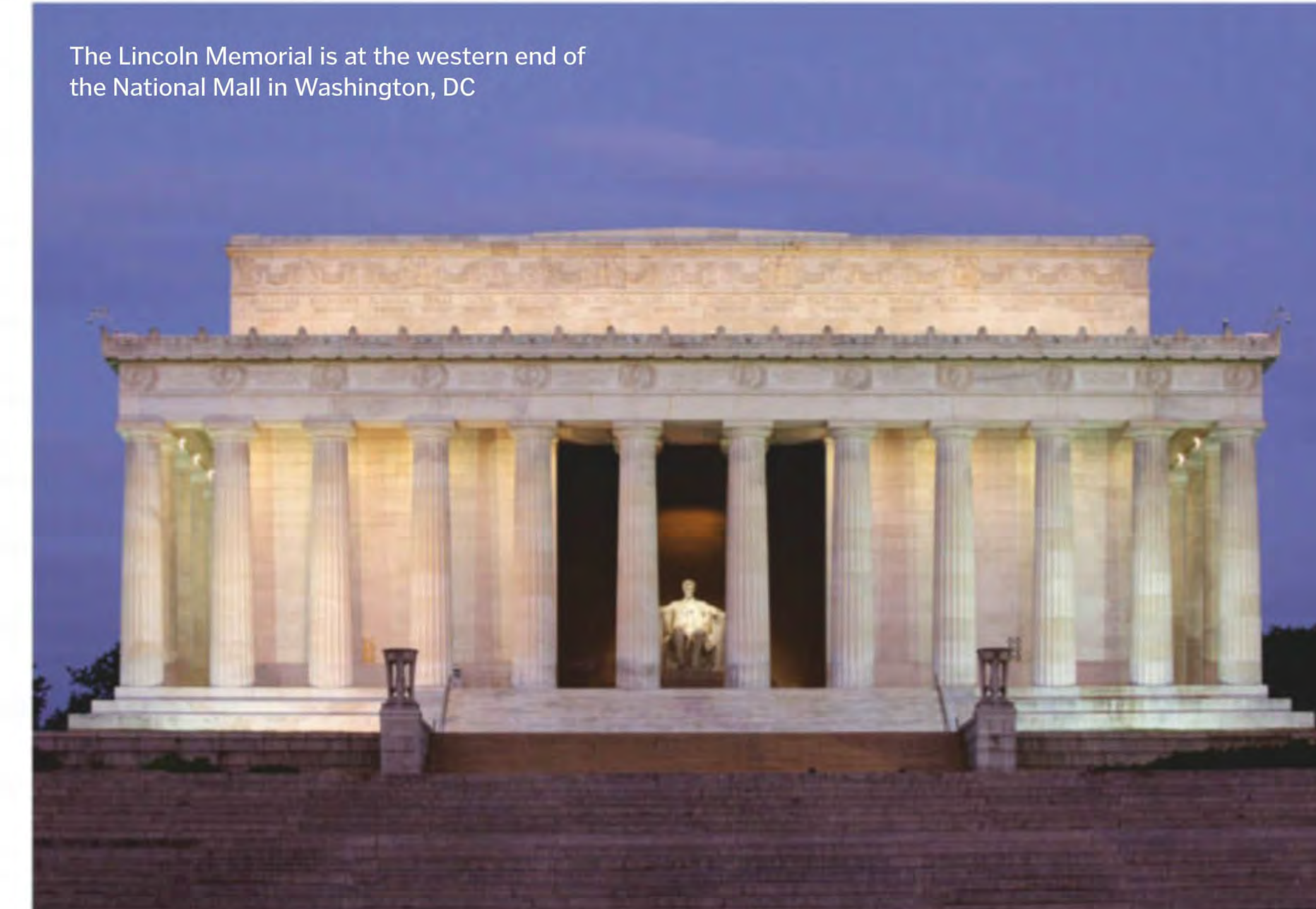

The Lincoln Memorial is at the western end of the National Mall in Washington, DC



The ceiling tiles were made from Alabama marble and soaked in paraffin to turn them almost translucent



The remote base is an extensive network of buildings and runways

# The truth about Area 51

Myths and conspiracy theories aside, what is really happening at this mysterious air base?

Isolated in the Nevada Desert, a dusty path leads to the heavily guarded Area 51 – an area marked only by orange poles. Covered with blinking surveillance cameras and sensors, the warning signs threaten that deadly force will be used on those who trespass. Has Area 51 been used as a landing spot designated for extraterrestrial passengers on a comet? Perhaps it is the home to aliens held captive by the government or the site of a reconstructed Moon to fake the landing footage? These imaginative stories from conspiracy theorists are very unlikely. Instead, Area 51 seems to be where secret military planes and weapons are tested.

The airfield first began service in WWII as an aerial gun range before the CIA established the site as the

location for Project AQUATONE. This project was developing Lockheed U-2, a strategic reconnaissance plane. The new aircraft would allow the military to fly at much higher altitudes and enable them to fly over the USSR without the risk of being shot down. Keeping this secret was a matter of national security, but people noticed the unusually high-flying craft that civilians couldn't explain, so when the test flights started it wasn't long before UFO sightings were reported.

While the U-2 operations stopped in the 1960s the base continued to test experimental planes. The base's primary purpose today is not publicly known, but we can say that almost certainly there are no aliens at Area 51. Almost.

## Top security

Whatever is happening in Area 51, the US Government has gone to a lot of trouble to make it difficult for anyone to find out. Historically, the site has been hidden from maps and not recorded on official documents. The land is patrolled by private security guards; they are kitted out with long-range viewing devices, night-vision equipment and 4x4 vehicles with monitors fed by movement sensors around the border of the base. If you are found to be trespassing on the grounds the guards are authorised to shoot to kill. Even if you were to gain top security clearance, you would still be kept in the dark about the true nature of Area 51. Staff arrive on unmarked planes, there are no windows at the facility and teams are not informed about anything outside their own duties.



Trespassing into Area 51 could prove fatal



The U-2 was the first plane known to the public that was developed at Area 51

## 5 FACTS ABOUT DECLASSIFIED PROJECTS

### 1 Tacit Blue and Have Blue (1975)

These two planes were the first developed with stealth technology and carried an active radar system to scan ground forces. Have Blue was a prototype for the F-117 Nighthawk stealth fighter and arrived at Area 51 in 1977.

### 2 The Bird of Prey (1992)

This single-seat, gull-wing experimental aircraft with a radar-evading shape and is rumoured to have also tested active camouflage – the changing of its surface's colour or luminosity to match the surroundings.

### 3 The Suntan (1960)

This plane was developed as the successor of the U-2 after one was shot down by the USSR. The Suntan used liquid hydrogen fuel and could fly at a much faster 3,200 kilometres per hour.

### 4 TR-3A Black Manta (1993)

A rumoured project that is described by the website of the Federation of American Scientists as a "subsonic stealthy reconnaissance aircraft", little is known about this aircraft.

### 5 Aurora (1985)

This code name was accidentally leaked in a budget document and described a reconnaissance and strike plane capable of flying at least 6,100 kilometres per hour and was able to reach anywhere in the world in a matter of hours.

© Getty

www.howitworksdaily.com

Special offer for readers in **North America**



# 4 FREE issues

When you subscribe\*

**“The action-packed science and technology magazine that feeds minds”**



Order hotline **+44 (0)344 848 2852**

Online at <https://www.myfavouritemagazines.co.uk/hiwusa>

**\*Terms and conditions** This is a US subscription offer. 4 free issues refers to the US newsstand price of \$9.99 for 13 issues being \$129.87, compared with \$87 for a subscription. You will receive 13 issues in a year. You can write to us or call us to cancel your subscription within 14 days of purchase. Payment is non-refundable after the 14-day cancellation period unless exceptional circumstances apply. Your statutory rights are not affected. Prices are correct at point of print and subject to change. Full details of the Direct Debit guarantee are available upon request. UK calls will cost the same as other standard fixed-line numbers (starting 01 or 02) included as part of any inclusive or free minutes allowances (if offered by your phone tariff). For full terms and conditions please visit: [bit.ly/magtandc](http://bit.ly/magtandc). Offer ends 31 March 2019.

**OFFER EXPIRES 31 Mar 2019**

# BRAIN DUMMIES

Because enquiring minds need to know...



To match the brightness of the Sun you would need 398,100 full Moons

## MEET THE EXPERTS

Who's answering your questions this month?



JODIE TYLEY



TOM LEAN



LAURA MEARS



JAMES HORTON



JO STASS

## What is the brightest object in the Solar System besides the Sun?

Robin Cleary

From Earth, the second brightest object in the Solar System is the Moon. Although it does not produce its own light, when it's in certain positions in orbit it reflects the Sun's light back to us. **JS**

## Why aren't there many naturally blue foods?

Edgar Malone

There are good reasons why most natural foods aren't blue. Partly it's chemistry – many leafy vegetables, for instance, like lettuce and spinach, are green because they contain green-coloured chlorophyll, which is used in photosynthesis. Meat is often red because it contains blood and proteins that are partly made of iron, which is red-tinted and needed to carry oxygen around animals' bodies. Evolution also plays a part – fruit tends to be brightly coloured to attract animals to eat it and scatter the seeds inside, so there are few blue fruits because they wouldn't stand out as well as those coloured red or orange. **TL**

Blueberries are one of the few naturally occurring blue foods

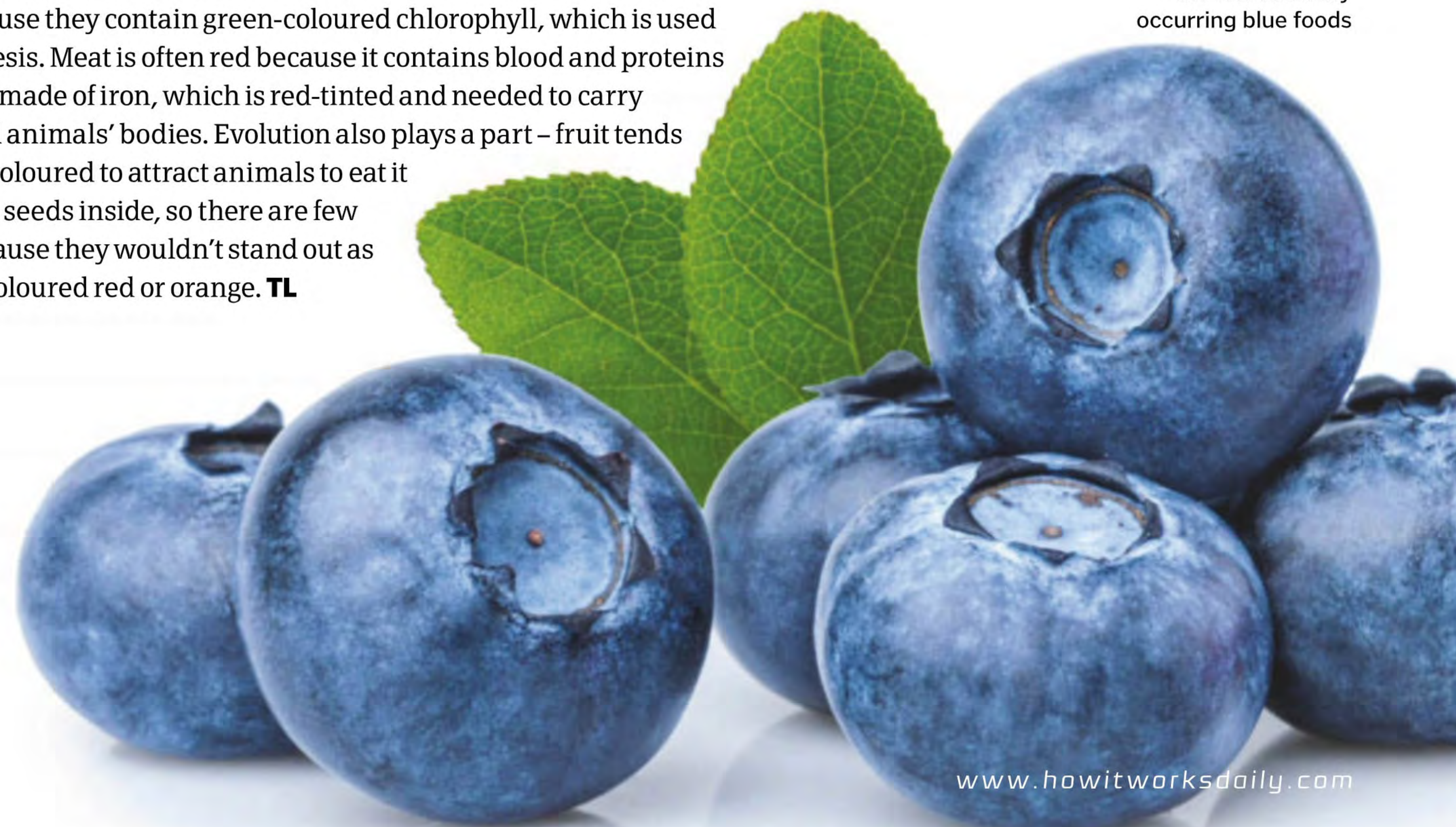

www.howitworksdaily.com

Want answers?

Send your questions to...

f How It Works magazine  
 @HowItWorksmag  
 @howitworks@futurenet.com

## What causes coffee breath?

Tim Marshall

Coffee is acidic, the caffeine it contains dries out the mouth, and milk contains a type of sugar called lactose. Bacteria love these three things, and they're the cause of coffee breath. **LM**



## Why are cats scared of cucumbers?

Sophie Oxbridge

You may have seen videos online of cats appearing to be spooked by cucumbers, but it's not cucumbers in particular that they're scared of. Cats are naturally very aware of their surroundings, as in the wild they would have to be on the lookout for predators, so if anything suddenly appears behind them they will likely find it threatening. It could be that cucumbers invoke such a strong reaction because cats initially mistake them for snakes. Regardless, it's best to avoid spooking your cat as it causes them stress. **JS**



Cats will be spooked by any unexpected object appearing behind them

## Do any countries still have military conscription?

Francis Lang

There are many countries that still require able-bodied men – and sometimes women – to complete military service. North Korea has the longest conscription period, with 11 years for men and seven for women. Other countries with mandatory service include Israel, Brazil, Greece, Switzerland and Syria, to name a few. Some have recently reintroduced it, such as Sweden, which voted to reinstate conscription in 2017 after abolishing it in 2010 after 100 years. **JT**

© Getty

www.howitworksdaily.com



A female Israeli soldier is taught the art of camouflage

NEW FROM HAYNES

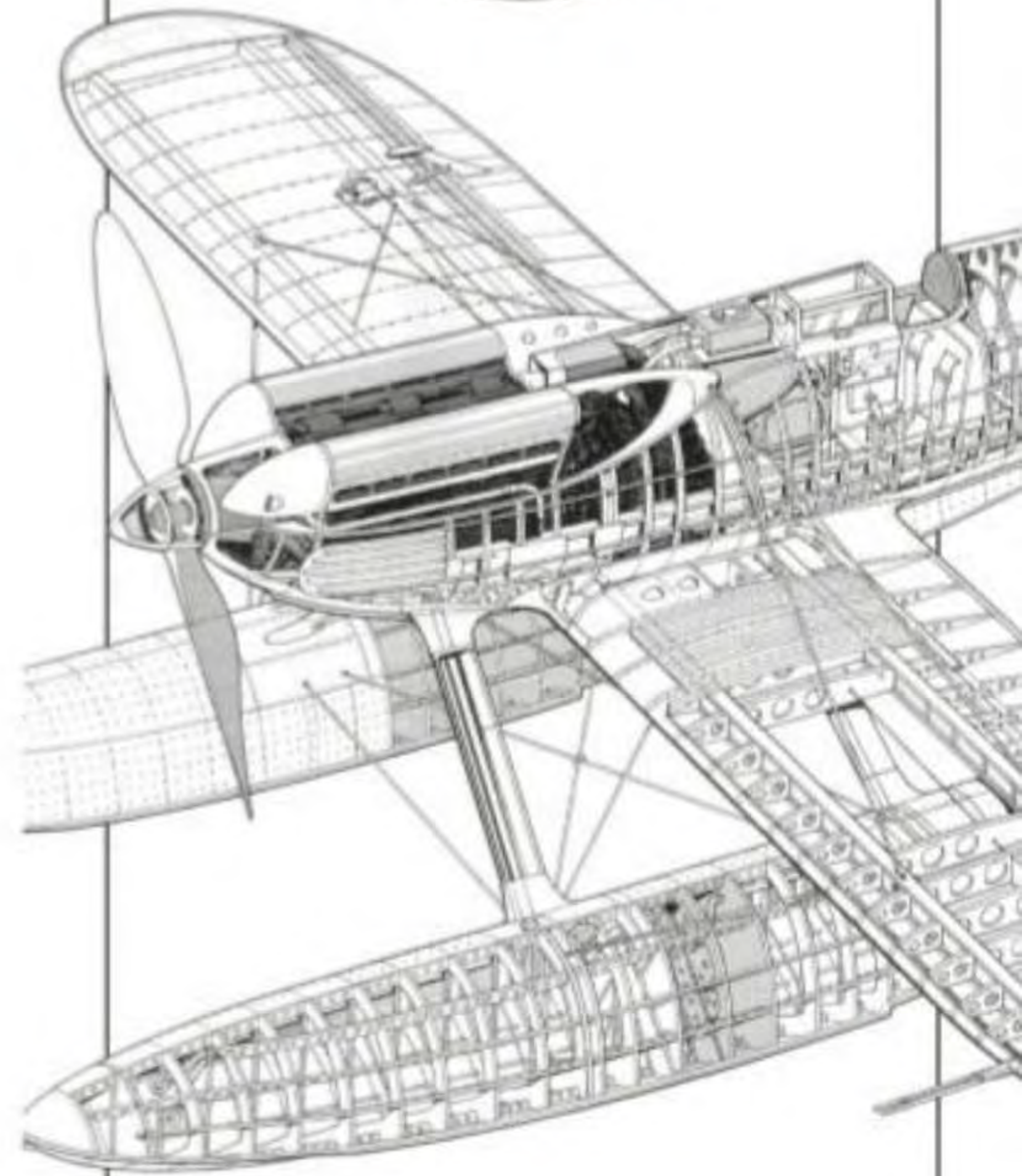

RRP £25.00

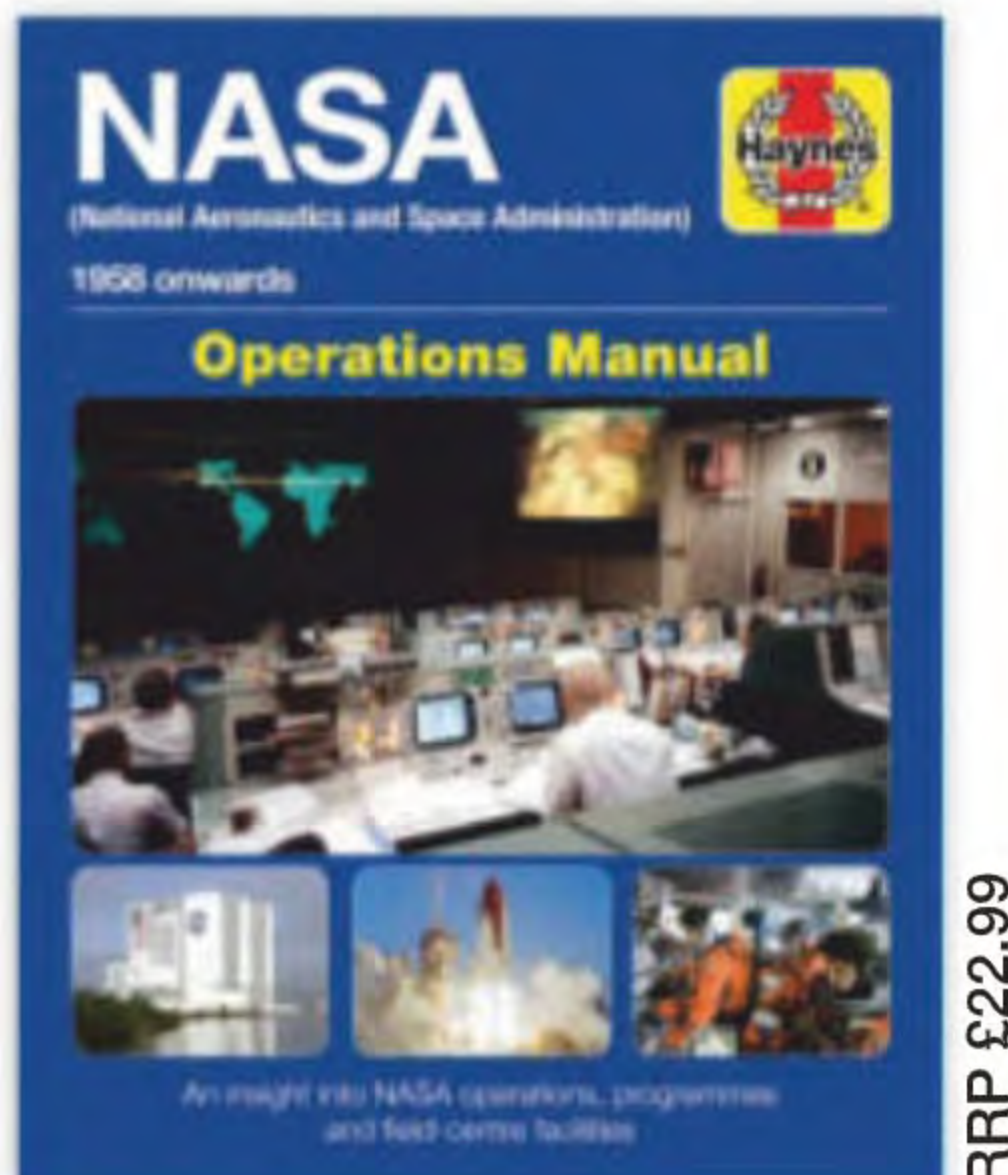

RRP £22.99



RRP £35.00

AVAILABLE AT HAYNES.COM AND ALL GOOD BOOKSHOPS



## Who invented roller skates?

Natasha Summers

1760s England may be remembered for many things, but the invention of the roller skates is certainly not chief among them. At a masquerade party in London, Belgium-born inventor John Joseph Merlin arrived wearing a set of skates that allowed him to zip around the room. Although his evening ended in disaster after he crashed into a mirror, the roller skate idea would persevere and remains a popular sporting and recreational activity over 250 years later. **JH**



Belgian inventor John Joseph Merlin first revealed his roller skates at a party in 1760



## How long does it take the Moon to orbit Earth?

Rupert Fenwick

The Moon only takes about 27.3 days to orbit the Earth. Early astronomers used this repetitive occurrence to calculate time, measuring dates from one full moon to the next. **JH**



The Boston Tea Party acted as a catalyst for the American Revolutionary War of 1775-1783

## What was the Boston Tea Party?

Amos Bramley

By 1773, colonists living in America were growing impatient with the rule of King George III and the British Parliament. The British were steeped in debt and hoped to recoup their losses by taxing their colonies across the Atlantic more heavily. The colonists protested this taxation and eventually the British relented, but they retained their heavy taxation on tea. In retaliation to this, an anti-British group of merchants known as the Sons of Liberty organised the 'Boston Tea Party', where they snuck aboard ships and threw 342 precious chests of tea into the harbour. Within the next two years the British and the colonists would be at war. **JH**

www.howitworksdaily.com



## Is fasting good for your health?

Ryan Butcher

It may be, but scientific testing is still underway. The original idea came from lab rats – when they eat less, they tend to live longer and have fewer health problems. Their insulin levels drop and their bodies start burning through any excess calories they've stored. Scientists are testing the idea on humans by cutting out snacks, eating earlier in the day and not eating for whole days at a time. But we are notoriously bad at sticking to diets, so research is ongoing. In the meantime, it's always good to check with a doctor before trying something like this yourself. **LM**



## Why does yawning help your ears 'pop'?

Gareth Pocock

When there is an imbalance of pressure either side of the ear, our eardrum can bulge inward or outward in response. 'Popping' our ears helps restore the eardrum to its normal position. As we yawn we open the Eustachian tube, which supplies air to the middle ear and equalises the pressure. **JH**

www.howitworksdaily.com



The English Reformation began during the reign of King Henry VIII (1509-1547)

## What was the English Reformation?

Lucinda Sears

After Henry VIII's demand for an annulment of his marriage to Katherine of Aragon was refused by Pope Clement VII, the king and his ministers set about breaking ties with the Roman Catholic Church. This sparked the creation of The Church of England in 1534, with the king as its supreme head. However, there was little change to church practices or ceremony until the reign of his son, Edward VI. Henry's daughter Mary I, who was a staunch Roman Catholic, reversed these Protestant reforms after her accession. It was Elizabeth I who more successfully reconciled the country's need for both Catholic traditions and Protestant reforms. **JT**



We owe our 24-hour days to the ancient Egyptians and their sundials

## How did we decide how long a second/minute/hour is?

Amanda Howells

The ancient Egyptians used the duodecimal system, which means they counted up in 12s (instead of 10s, like we do now). So, when they invented sundials to track daylight and star charts to track the night, they split the day and night into 12 parts each, forming the basis of modern hours. It was the ancient Greeks who then invented minutes and 'second minutes', and they used the sexagesimal system (counting in 60s). **LM**

© Getty



## How many World Heritage sites are there?

Mario Caretti

There are currently 1,092 UNESCO World Heritage sites around the globe, recognised for their cultural and natural importance. Italy is the country with the most sites at 54, which includes the famous leaning tower of Pisa. **JT**

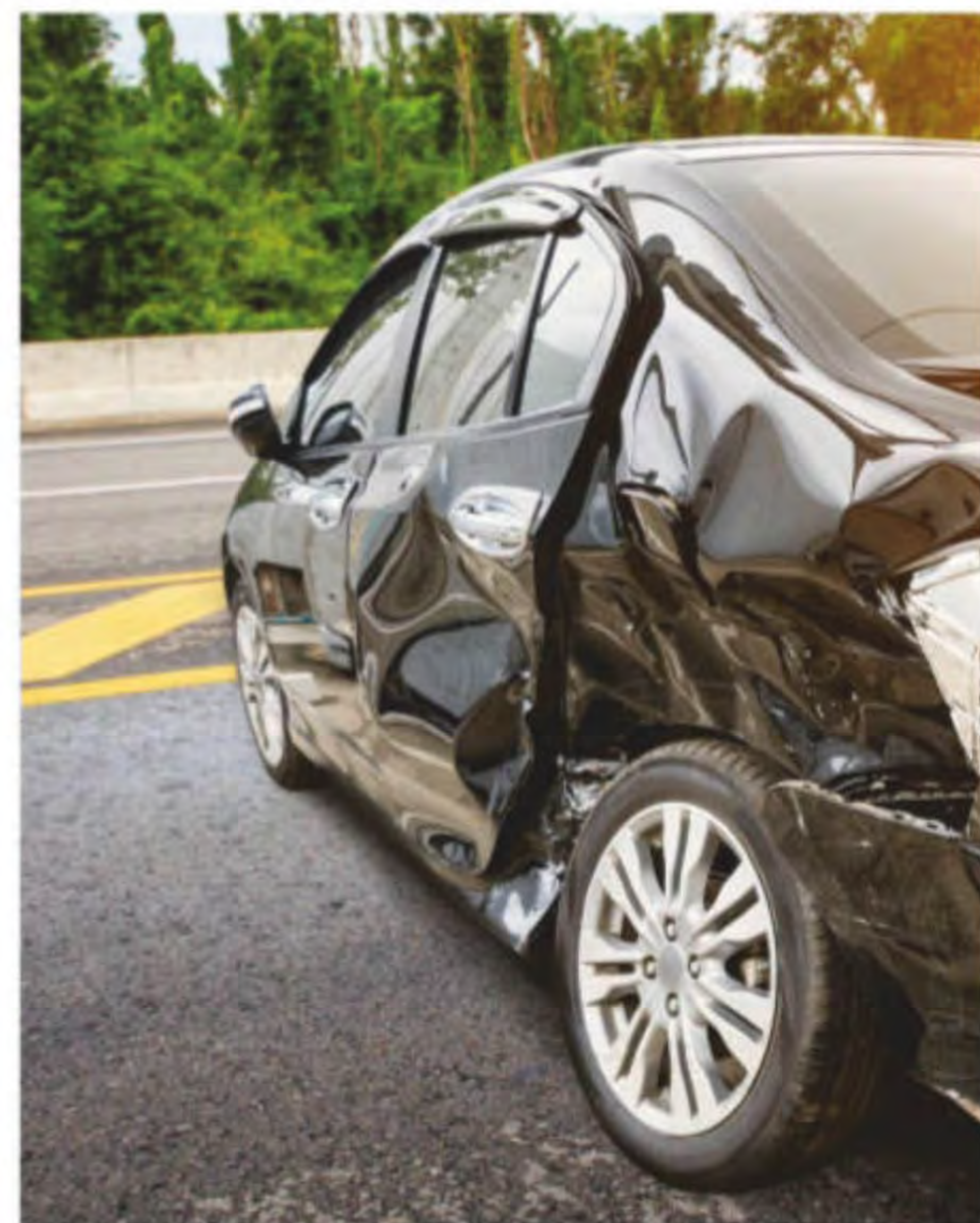

## Are cars more likely to be in an accident if they are a dark colour?

Sophie Hemmings

Black cars are more likely to have accidents than cars of other colours, probably because they are harder to see. Lighter shades, like white or silver, have the lowest accident rates. **TL**

## If computer components keep getting smaller, why are phones getting bigger again?

Faisal Khalil

We use smartphones to do much more today than a few years ago. More and more people use them for watching videos, playing games, running apps and even for work. Bigger screens are better for entertainment, such as watching movies, and make using apps easier, because touchscreen buttons can be bigger and more information can be shown on-screen. To increase entertainment and usability, manufacturers have been using bigger screens, which of course means bigger phones. **TL**



Smartphones are getting larger because we are using them to do more



## Why are olive oil bottles dark?

Janet Spears

Exposure to ultraviolet light and oxygen causes a decrease in the antioxidant contents of olive oil, reducing its quality. Therefore, it is best to store it in dark glass bottles or tins to protect it from light and air. **JS**

## Why do kids suck their thumbs?

Benjamin Entemad

Babies have a natural reflex to suck as this is how they feed, either from their mother's breast or a bottle. Even before they are born they will often suck on their fingers and thumbs in the womb. However, as well as serving as a survival instinct, the action of sucking is also soothing and comforting for children, which is why they will sometimes continue to do it even after they have been weaned onto solid foods. **JS**



Children will usually grow out of thumb-sucking when they are three to four years old

## Want answers?

Send your questions to...

How It Works magazine  
@HowItWorksmag  
@howitworks@futurenet.com



## Can people be allergic to water?

Sally Dyer

An adult body is made up of 60 per cent water, and yet it's possible to be allergic to this life-giving liquid. Aquagenic urticaria is a very rare condition in which a skin rash develops when in contact with water. It's so uncommon that the cause is still a mystery. **JT**



## What is white noise?

Lisa Basset

Just like white light is a combination of all the colours of the rainbow, white noise is a combination of different frequencies of sounds. The pattern is random and it makes a characteristic hissing noise. **LM**



## What was the first video-game console?

Marcus Spittles

The first video-game console was the Magnavox Odyssey, the brainchild of German-American inventor Ralph Baer.

On sale in 1972 for \$100, the Odyssey was primitive, yet despite having only simple black and white graphics and no sound, it played a range of fun sport, shooting, racing and educational games. **TL**

## The Ocean Book: How Endangered are our Seas?

Discover the science behind the threat to our oceans

- Author: Esther Gonstalla
- Publisher: Oekom
- Price: £19.99 / \$24.99
- Release date: Out now

The threat of global warming has never been greater. Scientists are now warning that if we don't do something serious to slow the rising temperatures on Earth we could cause irreparable damage to our planet within the next few years. At the centre of this are our oceans. They play an integral role in the regulation of temperature – as they start to warm more rapidly sea levels rise, temperatures rise, and our chance of survival falls.

This is the clear message of *The Ocean Book*, which pulls no punches as it talks you through the science behind rising temperatures. It starts by explaining how temperature changes throughout the Earth's history have altered the way life has formed and the close relationship between the seas and the climate. Then the bad news begins. Rising acidity from greenhouse gases; ocean currents in turmoil due to melting sea ice and higher precipitation; sea levels predicted to rise up to five metres (16 feet) in the next 300 years – it's not always an easy read. It moves onto endangered species and explains how overfishing is destroying habitats and how dolphins are hunted and killed near Japan. That's all before we've started talking about drilling, plastic pollution, oil spills, radioactivity and more.

If it sounds gloomy, that's because it is. The reality of the situation is that the oceans are being horrifically damaged by human activity, and without changing things it could soon

*"It starts with how life formed. Then the bad news begins"*

be beyond repair. This book won't be a pleasing read for everyone, but it does a fantastic job of illustrating each of the points with simple but effective graphics that really hit home. Annotated maps help you see how ocean currents flow, and images help explain the science, while the writing keeps things simple, sticking to the facts and explaining how bad things might be if we don't act fast.

It's not all doom and gloom – there are sections explaining the positive changes being made to our oceans through things like preservation areas and fish farms that are sustainable and environmentally friendly. These small glimpses give us an idea of how big industries can help protect the oceans, but they're few and far between in this necessarily unflinching look at the state of our seas.

★★★★★

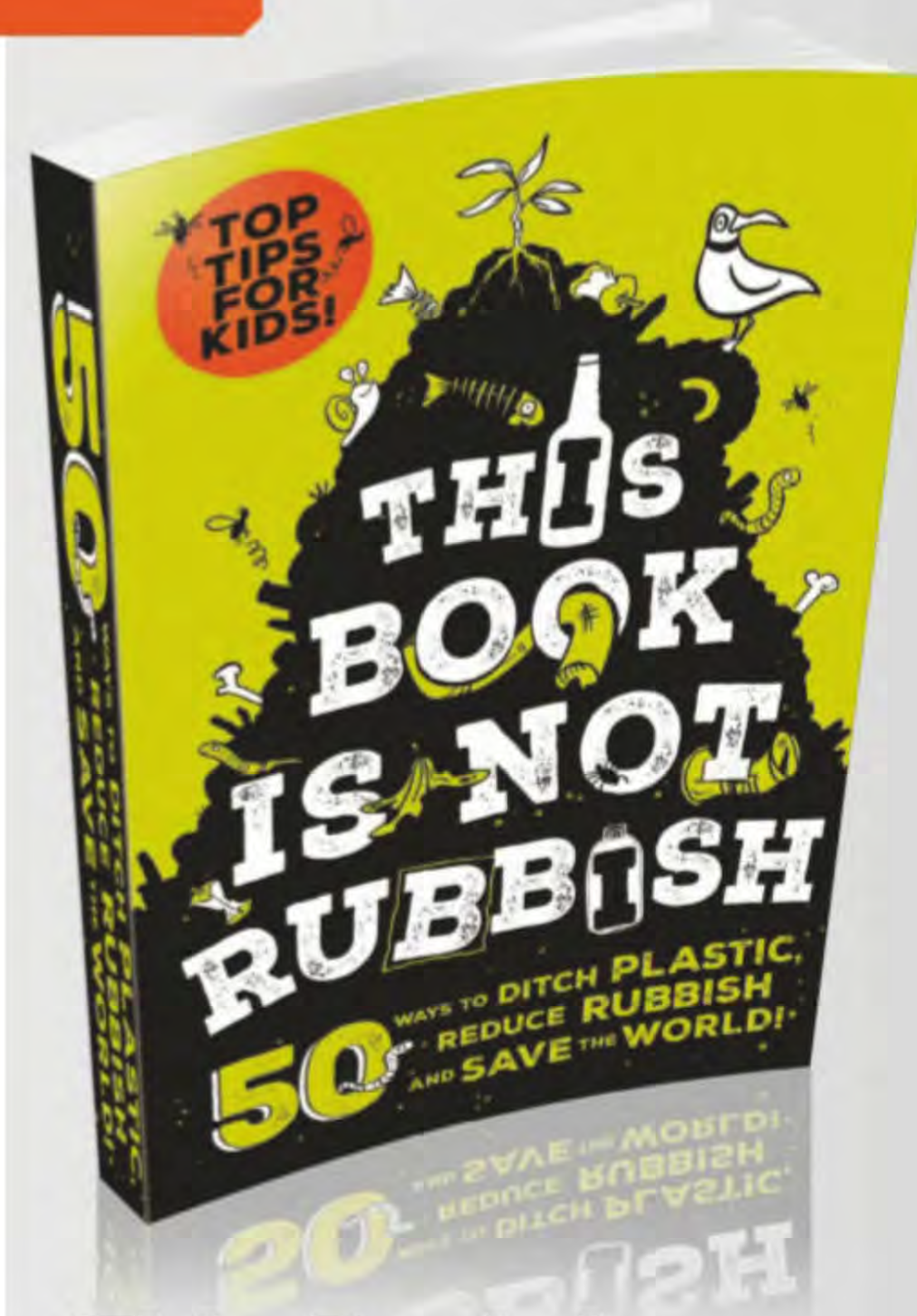
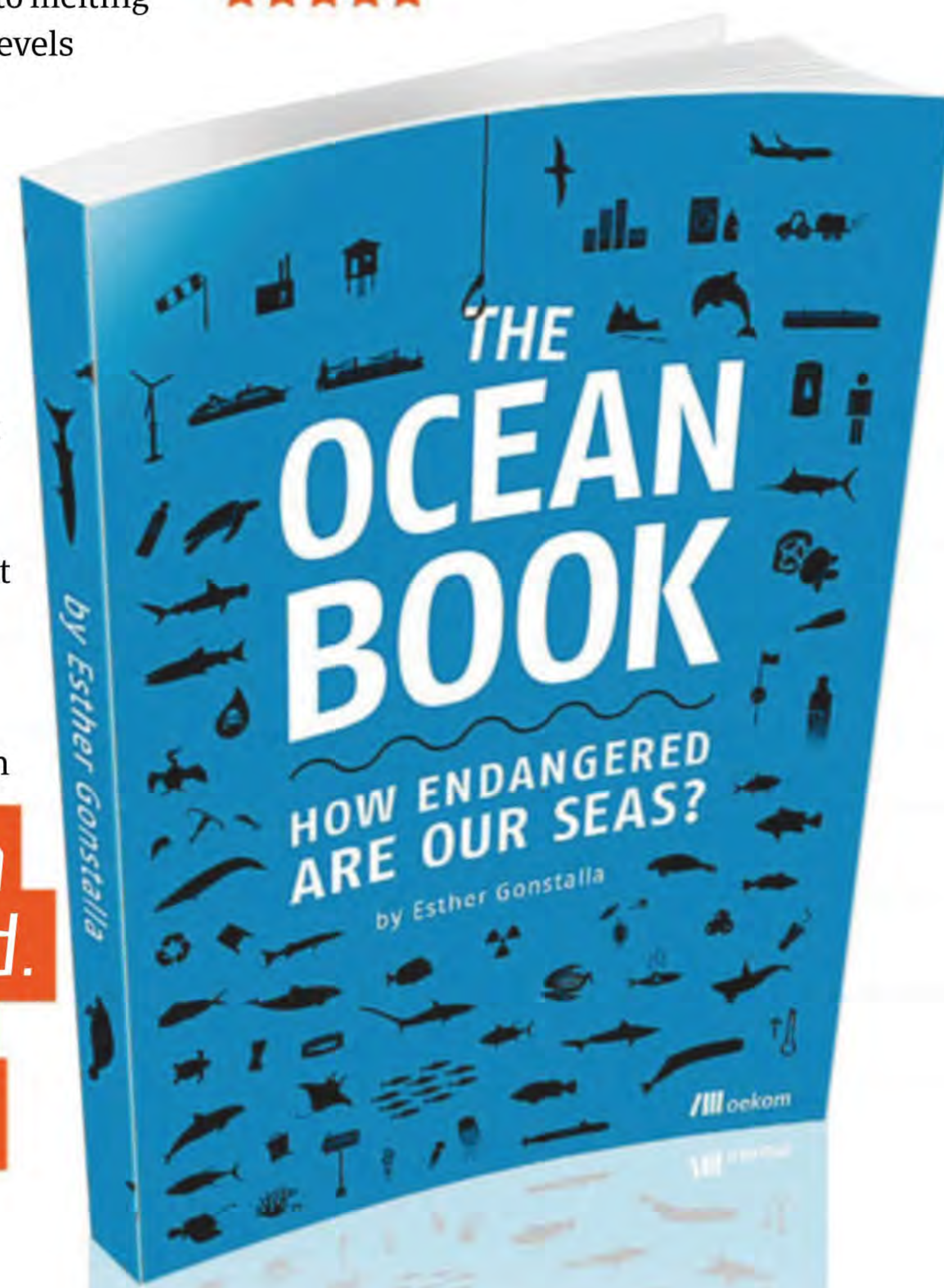

## This Book is Not Rubbish

We'll be the judge of that

- Author: Isabel Thomas
- Publisher: Wren & Rook
- Price: £6.99 (approx \$9)
- Release date: Out now

As far as book titles go, this one has quite the mission statement. Yet it's one that it seems determined to live up to, with the bulk of its content comprising 50 ways in which you can reduce your carbon footprint on the planet.

Some of these are more practical than others, such as turning off electrical appliances when you're not in the room, creating compost heaps and repairing things instead of just throwing them away. On the other hand, some of the information at hand is a bit demoralising. For instance, this book goes into great detail about the harm to the environment caused by farming animals for meat. While it's all useful information, the defeatist in us says that there's not a huge amount we can do about this individually.

Still, this is a very handy booklet for your kids (who will no doubt start lecturing you next time you put something recyclable in the general waste), especially if they're already hooked on the brilliant *Horrible History/Science* series.

★★★★★

www.howitworksdaily.com



## Darwin's Most Wonderful Plants: Darwin's Botany Today

The Beagle deal

- Author: Ken Thompson
- Publisher: Profile Books
- Price: £10.99 (approx \$14)
- Release date: Out now

Traditionally, we remember Charles Darwin for his voyage aboard *The Beagle* and the pioneering discoveries he made during this time. As plant biologist Ken Thompson points out, however, much of his work was undertaken back in the UK, and his groundbreaking *The Origin of Species* wasn't even published until 30 years after the end of his voyage, so there's a lot of ground left uncovered.

It's this dearth that Thompson seeks to explore, initially focusing on Darwin's primary plant-based interests (climbing plants and

insectivores) before moving onto the phenomena of cross-fertilisation and the different forms of plants that exist. There's a lot of ground to cover, but cover it Thompson does, marrying his keen insight into Darwin's life with a genuine passion for all forms of fauna.

Useful for both plant enthusiasts and those with just a passing interest, this is a perfect entry point into the life of Darwin and an ideal way to gain a further understanding of just how important his legacy is.

★★★★★

*"Thompson marries his keen insight with a genuine passion for all things fauna"*

www.howitworksdaily.com

## The Science of Supercars

Get your (super) engines ready...

- Author: Martin Roach, Neil Waterman, John Morrison
- Publisher: Mitchell Beazley
- Price: £20 / \$29.95
- Release date: Out now

Around 100 years ago we weren't that far beyond people walking in front of cars with flags. Now we have supercars. Obviously a lot happened in between, which is where this book is primarily concerned, detailing exactly how we got to the aerodynamic wonders we have today.

If you're worried that the above paragraph might ascribe the title as a bit misleading, then don't be; every step of the way the focus is shifted back to the present, harking back to

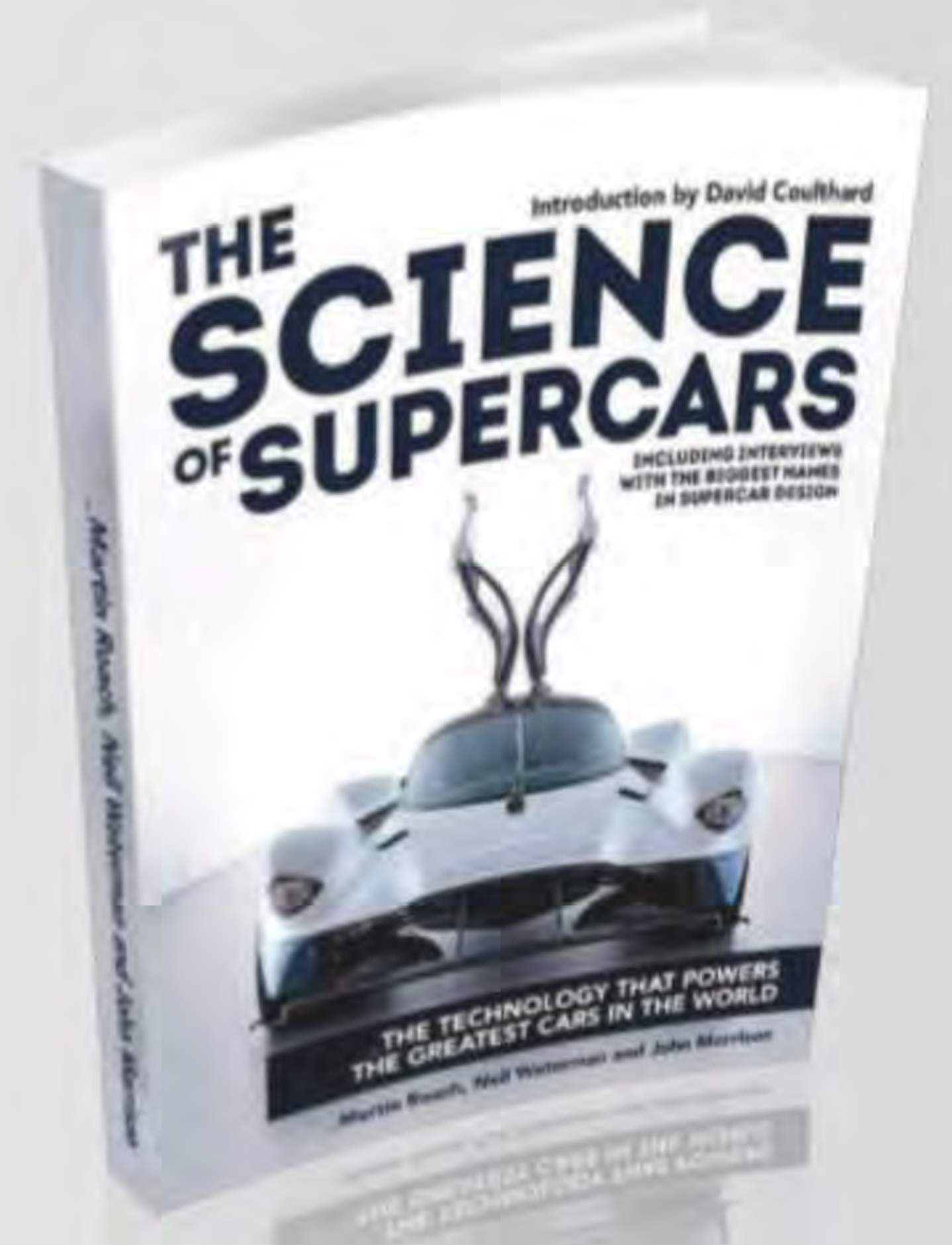

the early origins of implements like superchargers and direct fuel injection and the first use of aluminium when making cars. It all feels like it's leading somewhere, and you never feel in any doubt that you're on a journey.

Inevitably this will be of more appeal to petrolheads than anyone else, but even so, it's difficult to do anything other than commend the high level of presentation and production values on show here.

★★★★★

## NASA 1958 Onwards: Operations Manual

Space and beyond

- Author: Dr David Baker
- Publisher: Haynes
- Price: £22.99 / \$36.95
- Release date: Out now

We're fast running out of fitting superlatives to describe anything that comes out of the Haynes vault, but here we are again, and not a moment too soon. Wherever we are in history, NASA seems to remain a beacon of possibility and emblematic of the potential of discovery, making it a fitting subject matter for a Haynes manual.

Even though it starts in 1958, this still serves as an effective introduction to NASA's work and mission statement, detailing its

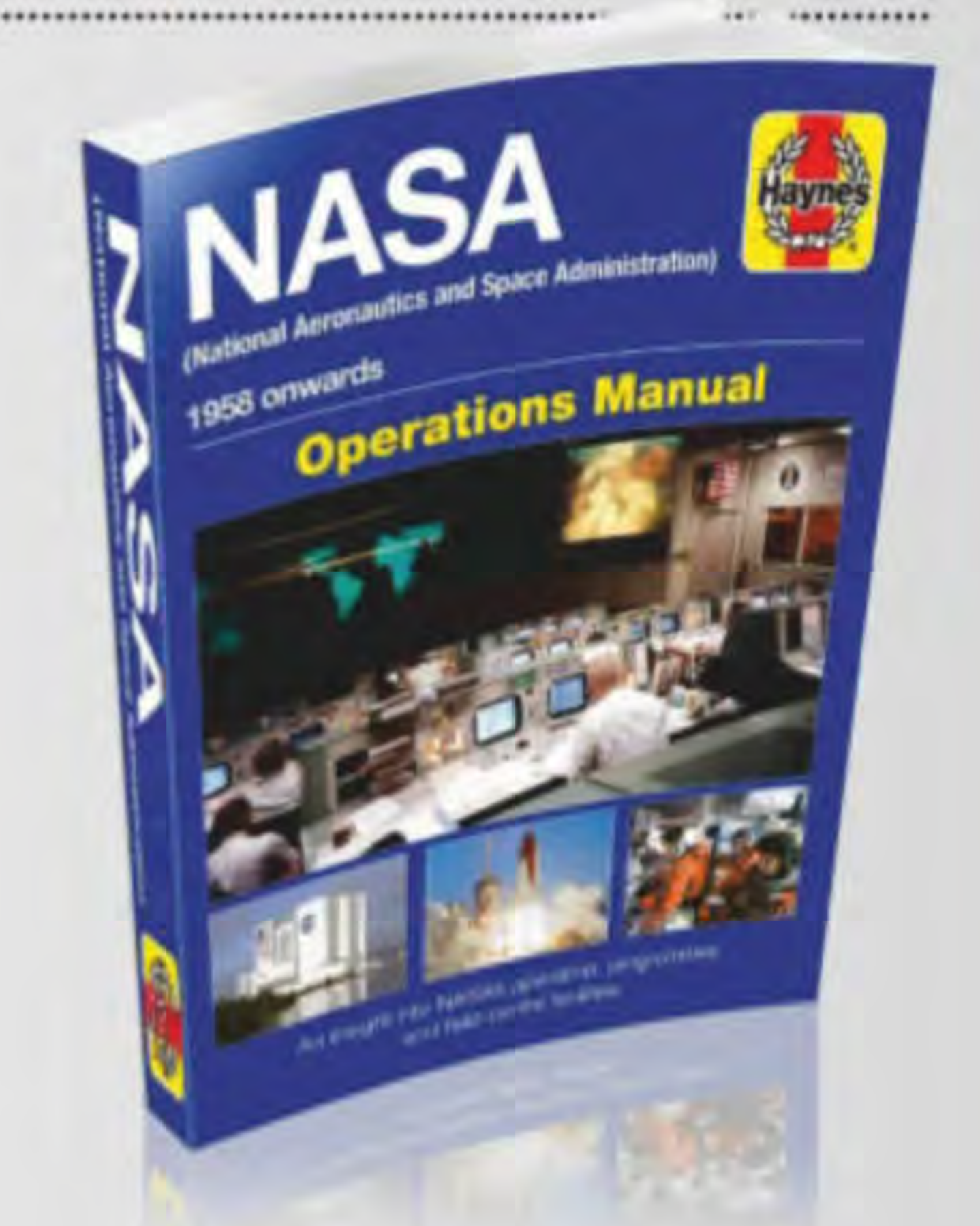

various accomplishments before looking ahead to what could be on the horizon. After this the organisation gets deconstructed (almost literally) brick by brick, as its field centres and their work are put under the microscope.

Being too technical isn't always a great thing as far as accessibility is concerned, but we've yet to find a Haynes manual that hasn't fully engrossed us, and the trick has been repeated yet again here.

★★★★★

## Wordsearch

S	R	B	R	A	D	I	A	T	I	O	N	D	X	C
T	A	N	D	R	O	I	D	T	Y	J	T	E	O	L
R	P	W	E	L	A	E	R	O	B	G	R	T	N	E
A	T	H	A	R	C	Q	A	M	N	T	O	E	U	A
T	O	B	L	M	E	E	R	I	K	J	R	S	N	
O	R	P	O	I	X	P	T	Y	C	L	A	G	Z	I
L	S	E	N	B	C	N	A	E	K	I	N	E	V	N
A	J	H	A	B	I	A	L	E	F	R	Q	N	O	G
U	W	E	I	R	S	T	V	R	H	U	T	O	P	
N	H	G	P	O	K	A	N	L	O	C	N	I	L	L
C	G	O	E	A	S	D	Q	J	G	M	E	U	R	O
H	I	F	U	R	B	X	C	Y	S	U	N	B	E	W
B	U	Q	I	A	N	T	A	N	G	C	F	E	T	Z
O	I	P	E	D	E	S	T	R	I	A	N	V	A	R
U	M	B	A	G	G	E	R	T	E	B	N	A	W	S

### FIND THE FOLLOWING WORDS...

- ANDROID
- BAGGER
- BIOPRINTING
- BOREAL
- CLEANING
- DETERGENT
- FROGS
- LINCOLN
- NASA
- PEDESTRIAN
- PIANOLA
- QIANTANG
- RADIATION
- RAPTORS
- STRATOLAUNCH
- TROJAN
- WATERLOO

## Quickfire questions

**Q1** The Hiawatha crater is \_\_\_\_\_ wide.

- 163 kilometres
- 31 kilometres
- 4.5 kilometres
- 2 kilometres

**Q2** What's the world's most endangered wild animal species?

- Orangutan
- Amur leopard
- Dodo
- Vaquita

**Q3** In what year was the first iPod sold?

- 1999
- 2000
- 2001
- 2002

**Q4** What's the world's lowest recorded ground temperature?

- 89.2° Celsius
- 59.5° Celsius
- 77.9° Celsius
- 46.4° Celsius

## Spot the difference

See if you can find all six changes we've made to the image on the right

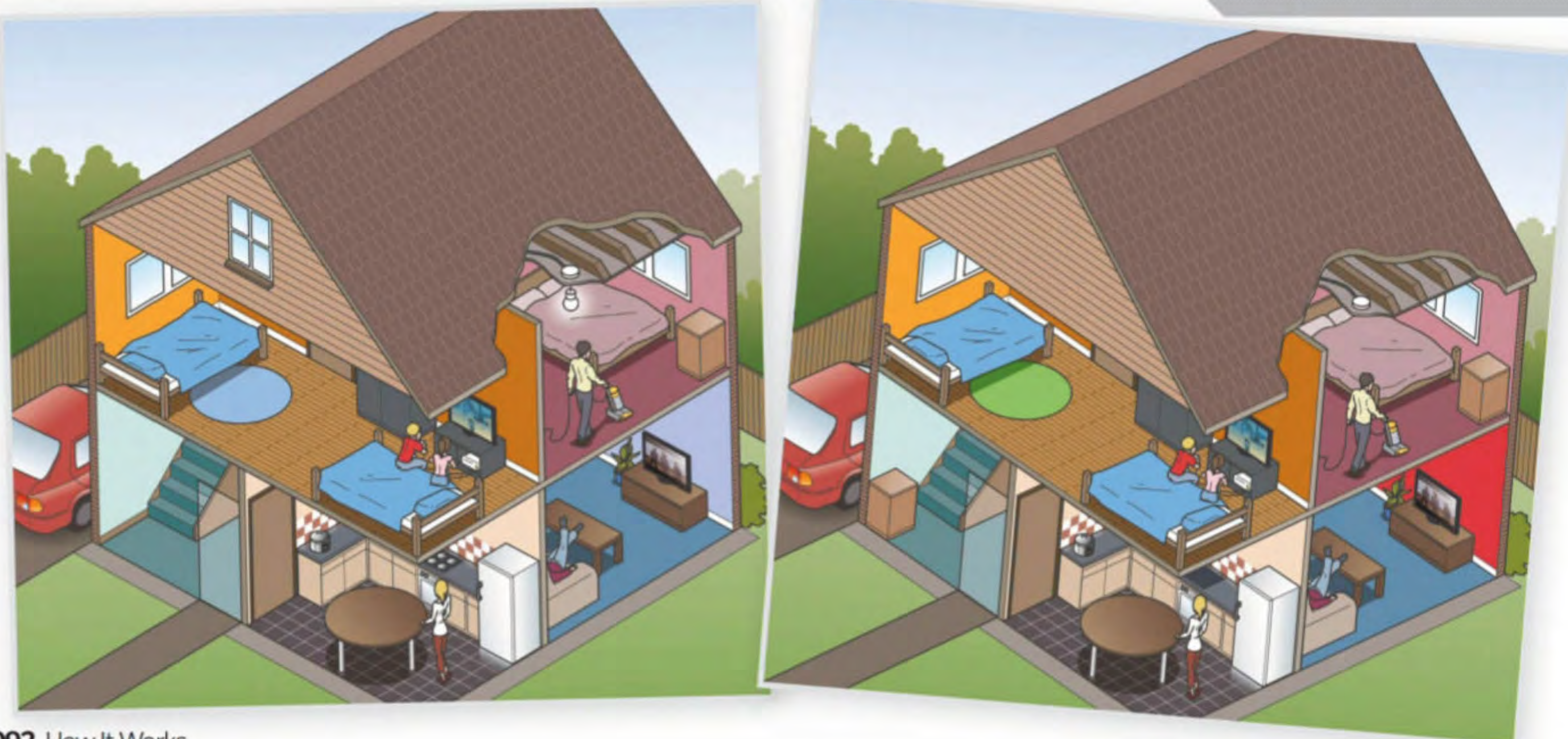

## Sudoku

Complete the grid so that each row, column and 3x3 box contains the numbers 1 to 9

### EASY

6	4	5			2			8
3		2		4	1	7	5	6
	7		9		5	4	2	3
4		1		3		6		5
2		9		8	7		3	4
		3	4		6	2		9
			7	2	4		9	1
5	2	4		9	3	8		
	1	7	6			3	4	

### DIFFICULT

6		2				5		1
3			7				9	2
5	7				6			
					8	4	3	6
1		9						
			3				5	
	8					7		
2					9	8		4
				1				

## What is it?

**Hint:** This Earth-like substance can be found in explosive places.



© Getty

For more brain teasers and to test your problem-solving abilities, enjoy our *Mensa Puzzle Book*, which is packed with challenging problems and puzzles designed by experts.

Available from [myfavouritemagazines.co.uk](http://myfavouritemagazines.co.uk)



## Spot the difference



## Check your answers

Find the solutions to last issue's puzzle pages

### Quickfire questions

- Q1** Human head, lion body
- Q2** 27%
- Q3** Canada
- Q4** Squash

## What was it?

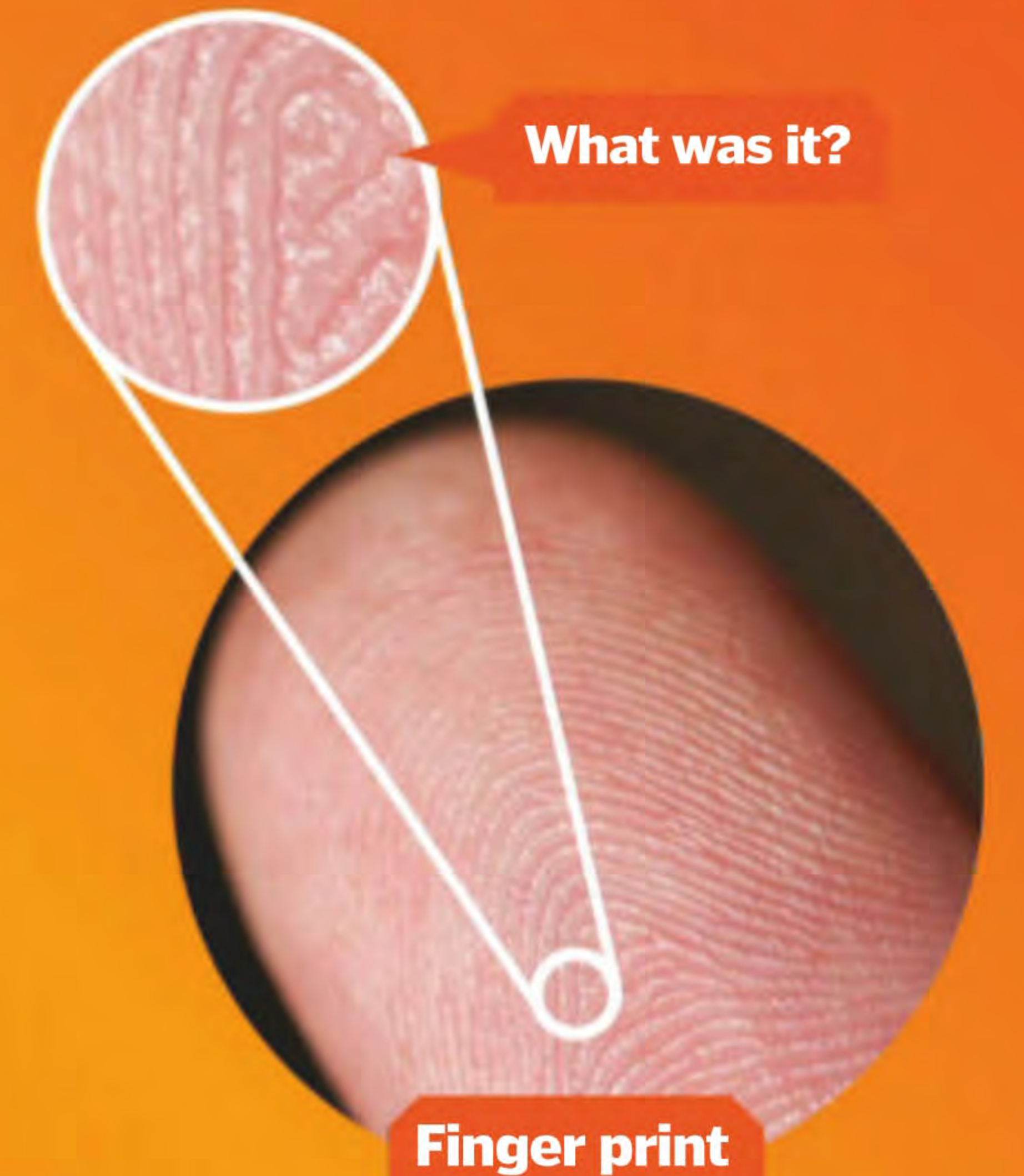

Finger print

**DON'T DO IT ALONE**  
IF YOU'RE UNDER 18, MAKE SURE YOU HAVE AN ADULT WITH YOU

**Get in touch**  
Send your ideas to...  
How It Works magazine  
@HowItWorksmag  
@howitworks@futurenet.com

## Put out a candle with CO2

Use science to amaze your friends by putting out a candle with a heavy gas



**1 Get ready**  
Before you start the experiment make sure you have everything you need. Get some vinegar and baking soda to create your gas, along with two large cups or pint glasses. You'll also need a candle and some matches.



**2 Create some CO2**  
First you should make your gas. Put a heaped teaspoon of baking soda into one of your glasses. Then add a tablespoon of vinegar. The reaction will produce a lot of bubbles, so don't be tempted to add any more to the mix.

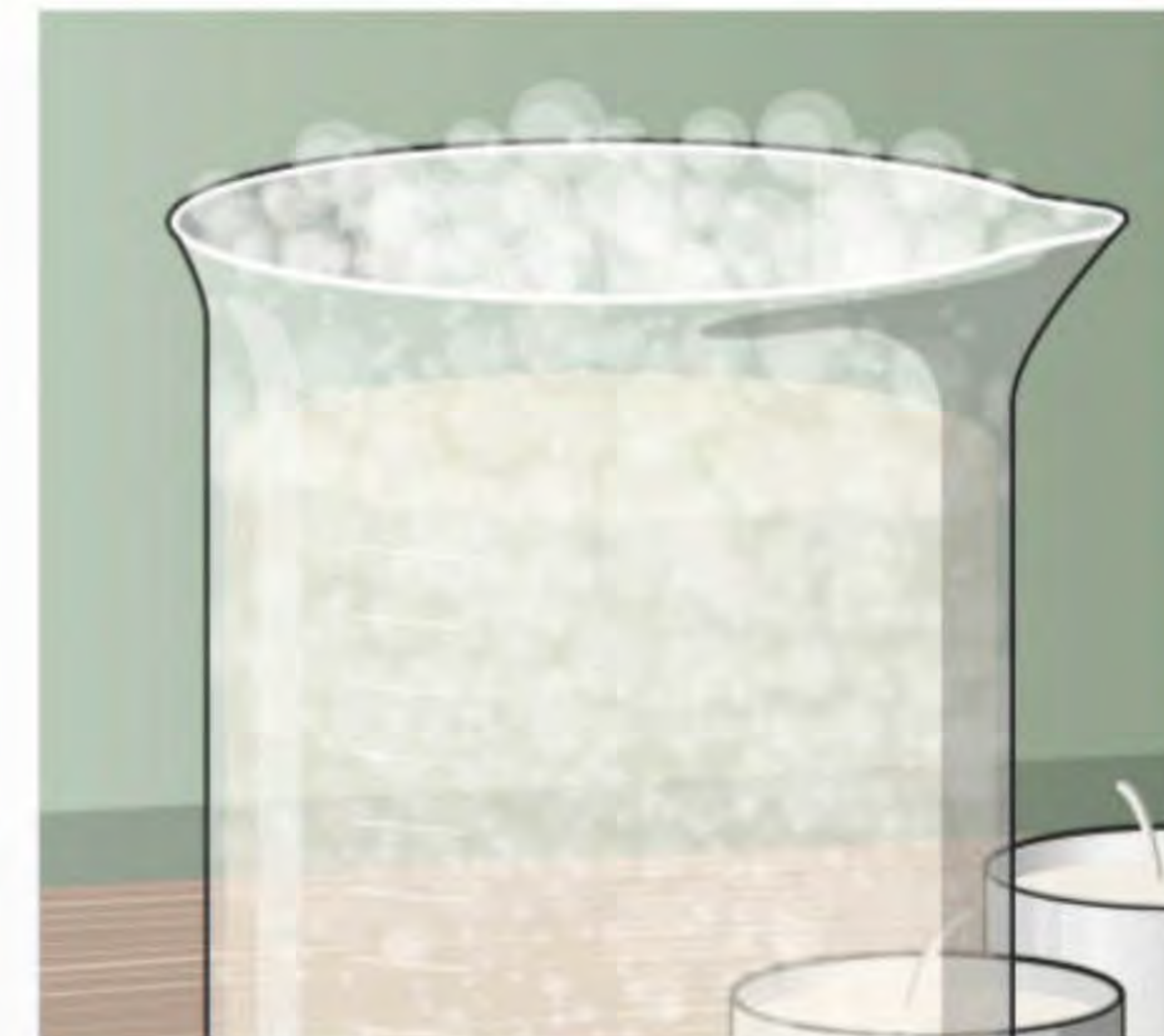

**3 Let it settle**  
Wait for the bubbles to go down and the gas to settle before you go any further. When the baking soda and the vinegar react together it produces carbon dioxide, or CO2. Because the CO2 is heavier than air it stays in the glass.



**4 Pour it into a cup**  
Now pour your CO2 from your first glass to your second. You won't be able to see the gas, so you'll need to use your imagination. Move slowly and try to avoid pouring the liquid in if you can.



**5 Light your candle**  
Now it's time to light your candle – ask an adult to help. Why not try lighting a row of tea lights and seeing how many you can put out with your gas?



**6 Put it out**  
Carefully lift your glass of CO2 and gently start pouring the gas onto the flame. Because it's heavier than air, as you tip the glass it will fall out, a little like pouring water. The flames will go out.

### SUMMARY...

Baking soda is a base and vinegar is an acid. When they react together they produce carbonic acid, but it's unstable and breaks down into CO2 and water. The CO2 pushes the air out of the glass and stays in there. Because flames need oxygen to burn, by pouring CO2 over the candles you take away the fuel they need, thereby extinguishing the flames.

**Had a go? Let us know!** If you've tried out any of our experiments – or conducted some of your own – let us know! Share your photos or videos with us on social media.

**Disclaimer:** Neither Future Publishing nor its employees can accept any liability for any adverse effects experienced during the course of carrying out these projects or at any time after. Always take care when handling potentially hazardous equipment or when working with electronics and follow the manufacturer's instructions.

### NEXT ISSUE

Blow a bubble inside a bubble inside a bubble

# WIN

# MEKAMON V2

This month we're giving away a MekaMon V2 – the world's first gaming robot. MekaMon is an interactive robot that can battle enemies in the virtual world.

For a chance to win, just answer the following question on our website:

In which year was the Lincoln Memorial opened to honour the 16th president of the United States?

a) 1922 b) 1914 c) 1961



**WORTH £249.99!**

MEKAMON

► Send your entries by email to [howitworks@futurenet.com](mailto:howitworks@futurenet.com) with the subject competition or write to us at How It Works, Richmond House, 33 Richmond Hill, Bournemouth, Dorset, BH2 6EZ

Terms and Conditions: Competition closes at 00:00 GMT on 21 February 2019. By taking part in this competition you agree to be bound by these terms and conditions and the Competition Rules: [www.futuretcs.com](http://www.futuretcs.com). Entries must be received by email or post by 00:00GMT on 21/02/2019. Open to all UK residents aged 18 years or over. The winner will be drawn at random from all valid entries received and shall be notified by email or telephone. The prize is non-transferable and non-refundable. There is no cash alternative.

## Get in touch

If you have any questions or comments for us, send them to...

How It Works magazine @HowItWorksmag howitworks@futurenet.com

In order to escape the Earth's gravitational pull, rockets must reach the planet's escape velocity



### Letter of the Month

## Escaping gravity's grasp

Dear HIW, The speed of gravity on something falling is around 122 miles per hour, yet to escape from gravity you need to go around 17,000 miles per hour. Why is it not around 130 miles per hour?  
Michael Richmond

Hi, Michael, and thanks for such a great question! For something as massive as a space rocket to escape Earth's gravity, it needs to exert a force greater than the gravitational pull the Earth has on it. This is its escape velocity, which is around 25,000 miles per hour to leave the planet and enter orbit.

The reason this speed is required is because a spacecraft does not use constant propulsion to enter space, as this would require more fuel than a spacecraft could carry. The spacecraft needs to achieve this velocity to counteract the opposing forces of gravity and air resistance to reach the outermost layers of our atmosphere without extra propulsion.

Theoretically, as long as an object is travelling at a constantly propelled speed, you're correct in thinking it's possible to escape the planet's gravitational force at a much slower speed. However, the escape velocity is the speed needed to break away from the pull once propulsion (for example, the thrusters of a spacecraft) has stopped.

The force of Earth's gravity is constant and the speed of falling objects is not the measure of its pull as other forces are in effect, such as air resistance, which slows down a fall.

Over a certain distance falling objects will reach what is called terminal velocity, which is the maximum speed an object can reach when falling. However, this differs for different objects due to their weight and surface area. The terminal velocity for an average skydiver in a free-fall position, for example, is around 122 miles per hour, but the speed of a falling spacecraft would be considerably more due to its far greater weight.



The earliest known controlled fire was ignited about 1.4 million years ago

## Making flames

Dear HIW, My class has recently done states of matter at school and I was wondering, what is fire? Is it a solid, liquid, gas or a chemical reaction? Thank you.  
Oscar, aged 12

Though solids, liquids and gases play a key role in the creation of fire, flames are actually a fourth state of matter known as plasma, a result of a chemical reaction. Take wood, for example. As a log reaches around 150 degrees Celsius the carbon stored within it will react with the oxygen in the air. This reaction emits light and heat as a by-product, forming the fire's flames in a process called incandescence. Depending on the intensity of the heat or additional elements in the fuel source the colour of the flames can change.



Myths were a way for people to explain the unexplainable

## Divine differences

Dear HIW, What is the difference between religion and a myth?  
Martin Green

That's a tricky one, Martin. The Oxford Dictionary defines religion as "the belief in and worship of a superhuman controlling power, especially a personal God or gods." Myth is defined as "a traditional story, especially one concerning the early history of a people or explaining a natural or social phenomenon and typically involving supernatural beings or events." Ancient Greek mythology, for example, does not have an original text or scripture in which it's outlined, unlike organised religions we see today.

## Fastest flight

Dear HIW, I have a question for you. What is the fastest recorded plane and what engines did it use?  
Christian Collins

The North American X-15 achieved the fastest speed reached by an aircraft with the exception of spacecraft. During its record-breaking flight back in 1967 the X-15 speeded through the skies at 7,274 kilometres per hour. To achieve this fast feat the X-15 was equipped with a rocket engine, which used anhydrous ammonia and liquid oxygen as propellant. This gave the aircraft a maximum thrust of around 25,850 kilograms.



The X-15 was in use for almost ten years beginning in 1959, and flew 199 missions

## Dolphin snooze

Dear HIW, If dolphins can't breathe underwater, then how do they sleep? Thank you very much.  
Yours sincerely,  
Oscar

Dolphins breathe through their blowholes. The blowhole has a muscular flap that covers the hole, and once the dolphin is at the surface of the water it will open this flap to breathe. Dolphins can take in more air with each breath, and red blood cells carry more oxygen. With a higher tolerance for carbon dioxide, while resting a dolphin will reduce its breathing rate to between three and seven times a minute. During sleep dolphins rest half their brain at a time so they can to monitor their breathing.



Dolphins only rest one half of their brain at a time to prevent them from drowning

What's happening on...

## social media?



This month, we asked you, given the opportunity, which one of the following would you most want to do if you visited Westworld?



**NEXT ISSUE...**  
Issue 122 on sale  
21 FEB 2019

Available in print from all good newsagents and myfavouritemagazines.co.uk, or as a digital edition for iOS and Android. To enjoy savings on the RRP and to make sure you never miss an issue, check out our subscription offers on pages 32 (UK) and 83 (US).

## HOW IT WORKS

Future PLC Richmond House, 33 Richmond Hill, Bournemouth, Dorset, BH2 6EZ

Editor **Ben Biggs**  
Senior Art Editor **Duncan Crook**  
Research Editor **Baljeet Panesar**  
Production Editor **Charlie Ginger**  
Staff Writer **Charlotte Evans**  
Staff Writer **Scott Duffield**  
Editor-in-Chief **Gemma Lavender**

Contributors  
Adrian Mann, Ed Crooks, Erlingur Einarsson, James Horton, Joanna Stass, Jodie Tyley, Jonathan O'Callaghan, Laura Mears, Mike Simpson, Nicholas Forder, Stephen Ashby, Steve Wright, The Art Agency, Tim Williamson, Tom Lean, Victoria Williams

Cover images  
Alamy, NASA, Royal Caribbean International, Getty, Ford  
Photography  
Alamy, Getty Images, NASA, Science Photo Library, Shutterstock, Thinkstock, Wikimedia  
All copyrights and trademarks are recognised and respected

Advertising  
Media packs are available on request  
Commercial Director **Clare Dove**  
clare.dove@futurenet.com  
Group Advertising Director **Mark Wright**  
mark.wright@futurenet.com  
Advertising Manager **Toni Cole**  
toni.cole@futurenet.com  
01225 687368  
Media Sales Executive **Jagdeep Maan**  
jagdeep.ma@futurenet.com  
01225 687353

International  
How It Works is available for licensing. Contact the International department to discuss partnership opportunities  
Head of Print Licensing **Rachel Shaw Rachel Shaw**  
licensing@futurenet.com

Subscriptions  
Email enquiries **contact@myfavouritemagazines.co.uk**  
UK orderline & enquiries **0344 848 2852**  
Overseas order line and enquiries **+44 (0)344 848 2852**  
Online orders & enquiries **www.myfavouritemagazines.co.uk**  
Head of subscriptions **Sharon Todd**

Circulation  
Head of Newstrade **Tim Mathers**

Production  
Head of Production **Mark Constance**  
Production Project Manager **Clare Scott**  
Advertising Production Manager **Joanne Crosby**  
Digital Editions Controller **Jason Hudson**  
Production Manager **Vivienne Calvert**

Management  
Managing Director **Alastair Lewis**  
Chief Content Officer **Aaron Asadi**  
Commercial Finance Director **Dan Jotcham**  
Editorial Director **Paul Newman**  
Head of Art & Design **Greg Whittaker**

Printed by Wyndeham Peterborough, Storey's Bar Road, Peterborough, Cambridgeshire, PE1 5YS  
Distributed by Marketforce, 5 Churchill Place, Canary Wharf, London, E14 5HU www.marketforce.co.uk Tel: 0203 787 9001  
ISSN 2041-7322

We are committed to only using magazine paper which is derived from responsibly managed, certified forestry and chlorine-free manufacture. The paper in this magazine was sourced and produced from sustainable managed forests, conforming to strict environmental and socioeconomic standards. The manufacturing paper mill holds full FSC (Forest Stewardship Council) certification and accreditation

All contents © 2019 Future Publishing Limited or published under licence. All rights reserved. No part of this magazine may be used, stored, transmitted or reproduced in any way without the prior written permission of the publisher. Future Publishing Limited (company number 2008885) is registered in England and Wales. Registered office: Quay House, The Ambury, Bath BA1 1UA. All information contained in this publication is for information only and is, as far as we are aware, correct at the time of going to press. Future cannot accept any responsibility for errors or inaccuracies in such information. You are advised to contact manufacturers and retailers directly with regard to the price of products/services referred to in this publication. Apps and websites mentioned in this publication are not under our control. We are not responsible for their contents or any other changes or updates to them. This magazine is fully independent and not affiliated in any way with the companies mentioned herein.

If you submit material to us, you warrant that you own the material and/or have the necessary rights/permissions to supply the material and you automatically grant Future and its licensees a licence to publish your submission in whole or in part in any/all issues and/or editions of publications, in any format published worldwide and on associated websites, social media channels and associated products. Any material you submit is sent at your own risk and, although every care is taken, neither Future nor its employees, agents, subcontractors or licensees shall be liable for loss or damage. We assume all unsolicited material is for publication unless otherwise stated, and reserve the right to edit, amend, adapt all submissions.

**FUTURE** Connectors. Creators. Experience Makers.

Future plc is a public company quoted on the London Stock Exchange (symbol: FUTR)  
www.futureplc.com

Chief executive **Zillah Byng-Thorne**  
Non-executive chairman **Richard Huntingford**  
Chief financial officer **Penny Larkin-Brand**

Tel +44 (0)1225 442 344

# FAST FACTS

Amazing trivia to blow your mind

THE SOLAR SYSTEM'S LARGEST ASTEROID, 4 VESTA, IS 578 KILOMETRES AT ITS WIDEST POINT

## \$17 BILLION

VALUE OF THE TREASURE ON THE SAN JOSÉ SHIPWRECK

50,000 YEARS  
THE AGE OF A MAMMOTH IVORY TIARA FOUND IN SIBERIA

## 550 TONS

THE DISPLACEMENT WEIGHT OF RUSSIA'S GIGANTIC ZUBR HOVERCRAFT

## 1.3 BILLION

NUMBER OF COWS ON EARTH

## 52

NAPOLEON BONAPARTE WON 52 OF THE 60 BATTLES HE FOUGHT

BALD EAGLES CAN DIVE AT UP TO 160 KILOMETRES PER HOUR TO SNATCH A FISH FROM THE WATER

## 20 million

NATIONAL MUSEUM OF BRAZIL EXHIBITS TRAGICALLY DESTROYED IN A 2018 FIRE

THE NYMPHS OF PERIODICAL CICADAS, A TYPE OF LARGE-BODIED INSECT, SPEND UP TO 17 YEARS IN THE GROUND BEFORE EMERGING ALL AT ONCE TO BREED

2021  
NASA'S ASTEROID HUNTER LUCY WILL LAUNCH IN OCTOBER 2021

## \$40,000

THE MINIMUM COST OF A DAY IN THE PARK OF HBO'S WESTWORLD

## FIND YOUR FAMILY'S SOLDIERS

Discover the part your ancestors played in Britain's military history

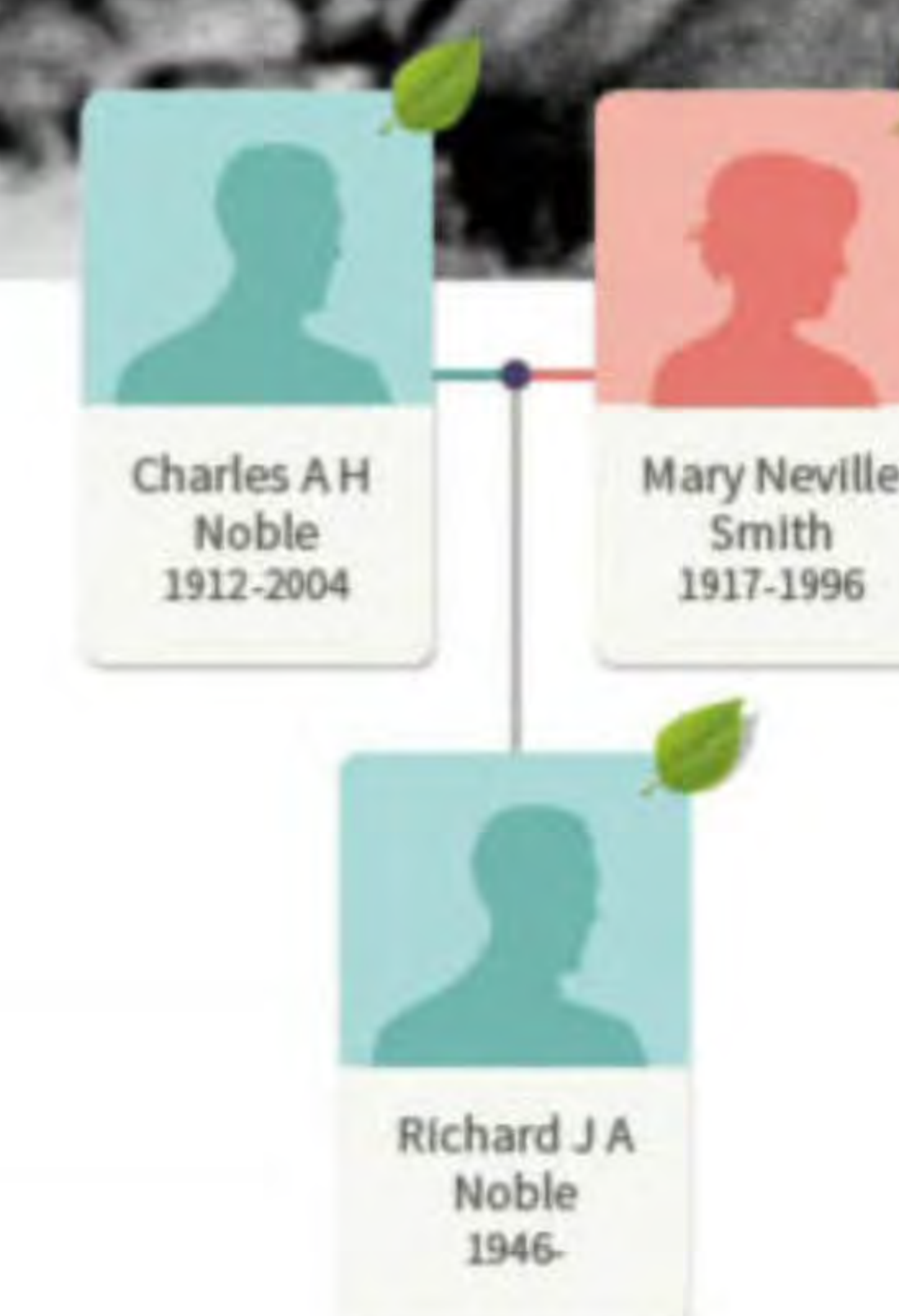

The most important family story is yours.  
Find it at [Ancestry.co.uk](https://www.ancestry.co.uk)

Ancestry provides the information you need to trace your family history around the world. Scour the globe with access to our entire library of more than 20 billion records.



Easy to get started with the details you already know.



More than 30 million UK military records ready to be discovered online.



Plus find details from census, parish, migration and probate records, and many more.



Ancestry Hints will guide you through the process.



Automatically created life stories for your ancestors add depth to the facts you find.

Find your story with a free trial at [Ancestry.co.uk](https://www.ancestry.co.uk)

# POWERBALL® GYROSCOPES

DEVELOP YOUR OWN GRAVITATIONAL FORCES...LIKE TINY SPINNING PLANETS



**280 Classic**  
The Entry One



**280 Autostart Classic**  
The All Round One



**Diablo Evo Autostart**  
The Muscle One



**280 Autostart Pro**  
The Best Selling One

## Titan

The Most Powerful One



**280 Autostart Fusion**  
The Amazing One

amazon



Over one thousand  
5-star reviews

 [powerballs.com](http://powerballs.com)

A zero gravitational training aid for NASA astronauts, Powerball® develops over 60 times its own weight in gyroscopic resistance and delivers strengthening and rehabilitation for the arms & wrists unlike anything else on (or off) this planet.